

USER MANUAL



PENTHA GB2 MONITOR



INTRODUCTION

First of all, we thank and congratulate you for purchasing this product.

Our commitment to achieving the satisfaction of customers like you is manifested through our ISO-9001 certification and the manufacture of products like the one you have just purchased.

Its advanced technology and strict quality control will ensure that customers and users enjoy the numerous features that this device offers. To get the most out of them and ensure proper operation from day one, we recommend that you read this instruction manual.

CONTENTS

Introduction.....	2
Contents.....	2
Safety precautions.....	2
Characteristics.....	3
System operation.....	3
Description of the monitor.....	
Description.....	4
Function push button and LEDs.....	4
Connection terminals.....	4
DIP switch.....	4
Setting the monitor's address codes.....	5
Installing the monitor in a wall mounting connector.....	6
Installing the monitor in an embedding box.....	7
Operation.....	
Description and communication with hearing aids (PENTHA GB2/H monitor only).....	8
1.1 Receiving a call from the door panel.....	8
1.2 Call not answered (missed call).....	9
1.3 Ending a call from the door panel.....	9
1.4 Answering a call from the door panel.....	9
1.5 Answering a call from the door panel, activating the light (SAR-GB2 required) and displaying cameras (DQ-CAM-GB2 required).....	10-11
Monitor screen and volume settings menu (brightness, colour, contrast, communication volume and screen format).....	12-13
User menu.....	
Accessing the menu.....	14
Displaying main door panel image.....	14-15
Displaying door panel images.....	15-16
Displaying camera pictures (DQ-CAM-GB2 module required).....	16-17
Text messages.....	17-21
Viewing photos and videos of door panel calls/cameras and deleting photos and videos.....	22
MicroSD card (information, copying and formatting).....	23-24
Viewing the call log.....	25
Intercom (transmission within the same apartment and between apartments) and call to guard monitor.....	26-30
Configuring divert call phone numbers and GSM-GB2 device information.....	31-32
Activating external light (SAR-GB2 module required).....	32
Enabling / disabling do not disturb or divert call modes.....	33-34
Settings (volume/ringtones, date/time, language, default settings, installer menu, etc.).....	35-41
Configuring from the monitor menu (address, master/slave and displaying slave monitor image in call).....	41-43
Cleaning the monitor.....	43
Annex: Changing the time range of the monitor's day mode.....	45-46

SAFETY PRECAUTIONS

- Avoid overtightening the screws of the monitor's wall mounting connector.
- **Always disconnect the power supply** before making modifications to the device.
- The fitting and handling of these devices must be carried out by **authorised personnel**.
- All of the wiring must run at least **40cm away from any other wiring**.
- Install the monitor in a dry protected location free from the risk of dripping or splashing water.
- Do not place in humid, dusty or smoky locations, or near sources of heat.
- Before connecting the device to the mains, check the connections between the door panel, power supply, distributors and monitors.
- Always follow the instructions contained in this manual.

CHARACTERISTICS

- Hands-free monitor.
- 7" TFT colour screen.
- Monitor with simple installation (non-polarised 2 wire BUS).
- The PENTHA GB2/H monitor interacts with hearing aids equipped with T-mode, making conversation between the door panel and apartment easier.
- Capacitive menu access and (slave monitor only) start/stop communication button.
- Touch screen for access and selection of menu functions:

User menu:

- Displaying door panel images.
- Displaying camera pictures (DQ-CAM-GB2 module required).
- Sending and receiving text messages from the same apartment and other apartments in the building.
- Viewing photos or videos of missed calls (microSD card up to 16 GB and Class 10 required).
- Door panel or intercom call log (received and made).
- Intercom calls within the same apartment.
- Intercom calls between apartments.
- Call to guard.
- Activating external light (SAR-GB2 module required).
- About: Information, access to the installer menu and default settings (restore).
- Settings: Ringtone, ringtone volume, date / time, language and enabling intercom between apartments.













Installer menu:

- Monitor as master or slave 1, slave 2 or slave 3. Up to 4 monitors per apartment.
- Enabling the menu to be viewed when the Bus is busy.
- Enables the monitor address to be programmed from the installer menu.

Screen, volume and control settings menu: (during auto switch-on or communication).

- Manual photo or video recording (microSD card up to 16GB and Class 10 required).
- Door 1 opening control / door 2 opening control.
- Start/stop communication control.
- External light control (SAR-GB2 module required).
- Scene: Normal, bright, soft or user picture.
- Brightness, contrast and colour.
- Screen format (4:3, 16:9 wide and 16:9 high).
- Displaying camera pictures (DQ-CAM-GB2 module required).
- Different ringtones to identify the origin of the call (door panel, intercom or apartment door).
- DIP switches for setting the monitor address (call code) and end of line.
- Input for call from the apartment door.
- SAR-12/24 call repeater output (12Vdc/50mA maximum).

SYSTEM OPERATION

- To make a call, the visitor must press the button of the apartment; an audible sound indicates that the call is being made and LED  will turn on. If vocal synthesis is enabled, a 'Call is in progress' message appears indicating that a call is being made. At this moment, the apartment's monitors receive the call. If another apartment is called by mistake, press the button for the correct apartment and the first call will be cancelled.
- The call lasts for 40 seconds and, when received, the image appears on the master monitor without the visitor knowing. To view the image on a slave monitor, this function needs to have been enabled on the monitor. House kit application: the image appears on the monitor (with code 0 'apartment 1' or monitor with code 16 if the call is in 'apartment 2') when receiving the call without the visitor being alerted. If the call is not answered within 40 seconds, LED  will turn off and the channel will be freed.
- To establish communication, press option  on the screen of the master monitor or the  logo on the front of any slave monitor in the apartment (unless the 'display image in call' function is enabled on the slave monitor, in which case, option  must be pressed), and LED  on the door panel will illuminate. If the monitor is a PENTHA GB2/H with icon  on the front, make sure that the hearing aid is between 15 and 25 cm away from the monitor to ensure maximum audio quality during communication with the door panel.
- Communication will last for one and a half minutes or until option  on the monitor screen is pressed. When communication has finished, LEDs  and  will turn off and the channel will be freed. If vocal synthesis is enabled, a 'Communication is finished' message will indicate that the call is over.
- To open door 1 or 2, press option  /  on the monitor screen during the call or communication processes: one press will activate the lock release for 5 seconds and LED  will also illuminate for 5 seconds. If vocal synthesis is enabled, a 'Door Opened!' message will be indicated on the door panel.
- The description of the function push button and LEDs can be found on p. 4.

DESCRIPTION OF THE MONITOR

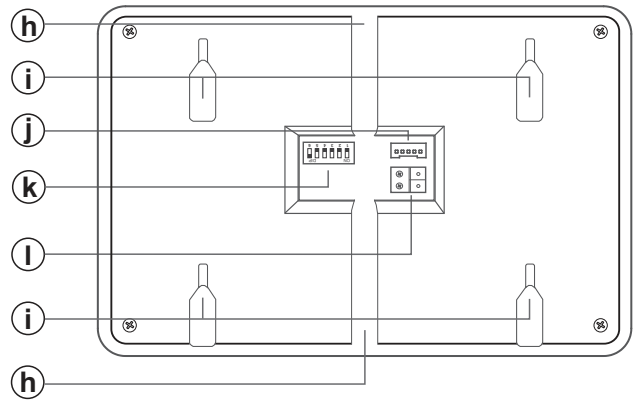
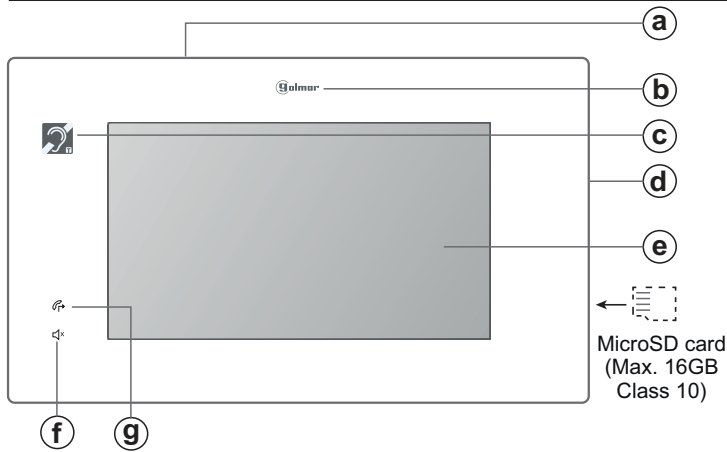

- a. Microphone.
- b. Monitor status light and capacitive menu access (in standby) / slave monitor communication start button.
- c. Communication with hearing aids (PENTHA GB2/H). Set the hearing aid switch to T-mode, see p. 8.
- d. Speaker.
- e. 7" TFT colour screen.

- f.. 'Do not disturb' mode LED.
- g. 'Divert call' mode LED.
- h. Vertical wiring entry.
- i. Connector fixings.
- j. Connector.
- k. DIP switch.
- l. Bus connection terminals.

LEDS:

- 'Divert call' mode LED:**
Off: 'Divert call' mode disabled.
On: 'Divert call' mode enabled.
- 'Do not disturb' mode LED:**
Off: 'Do not disturb' mode disabled.
On: 'Do not disturb' mode enabled.

Function push button / Monitor status light:

Function push button: Menu access (in standby) / During a call process, it initiates communication in a slave monitor (unless the 'display image in call' function is enabled - see 'System operation' on p. 3).

Monitor status light:

Standby: Light fixed (low intensity).
Call: Light blinking.
Communication: Light fixed.
Missed call: Low and variable intensity light.

Connection terminals and DIP switch:

Connection terminals:

- L1, L2: Bus connection (non-polarised).
- HZ+, HZ-: Door bell connection.
- CALL REPEATER, GND: Call repeater connection (SAR-12/24). (12Vdc/50mA maximum).

Configuration DIP switch:

DIP 6: Configures the end of line. Leave in the ON position in monitors where the bus cable terminates. Set to OFF in intermediate monitors only.

DIP 1 to DIP 5: To set the monitor address (addresses 0 to 31).

The switches set to OFF have a zero value.
The values of the switches set to ON are shown in the table below.
The monitor code is the sum of the values of the switches set to ON.

Table of values

Switch n°:	1	2	3	4	5
Value when ON:	1	2	4	8	16

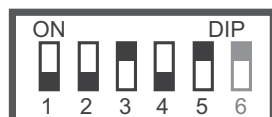

Example: 0 + 0 + 4 + 0 + 16 = 20

- (WHITE): HZ+
- (GREEN): HZ-
- (RED): CALL REPEATER
- (BLACK): GND
- (YELLOW): DO NOT USE

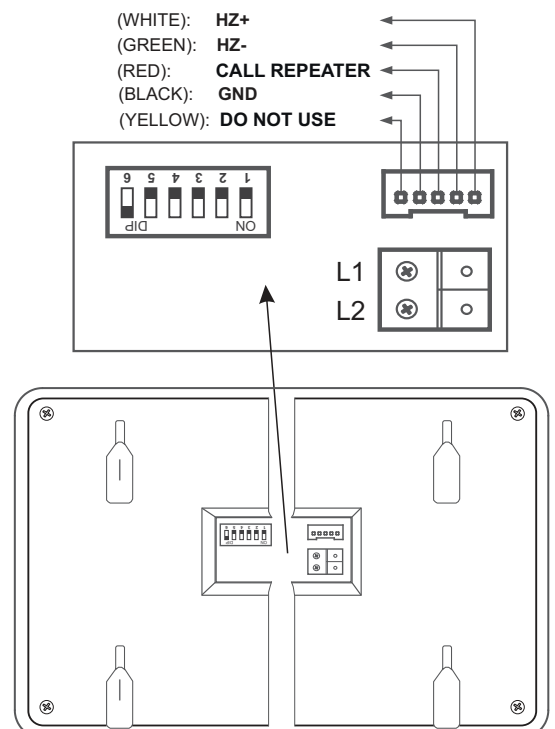

DESCRIPTION OF THE MONITOR

Setting the monitor's address codes (addresses 0 to 31):

DIP 6: Configures the end of line. Leave in the ON position in monitors where the video cable terminates. Set to OFF in intermediate monitors only.

DIP 6 to ON



DIP 6 to OFF



DIP 1 to DIP 5: To set the monitor address (addresses 0 to 31).

Code 0/32 (*)



Code 08

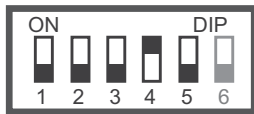

Code 16



Code 24

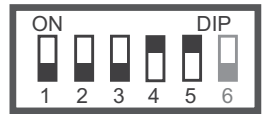

Code 01



Code 09



Code 17



Code 25



Code 02



Code 10



Code 18



Code 26



Code 03

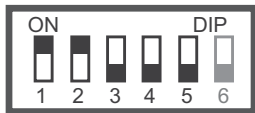

Code 11



Code 19



Code 27



Code 04



Code 12



Code 20

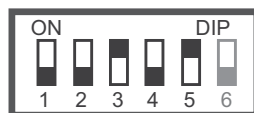

Code 28



Code 05



Code 13



Code 21

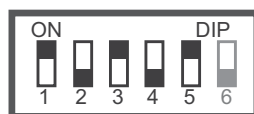

Code 29



Code 06

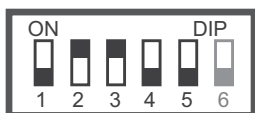

Code 14

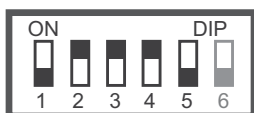

Code 22

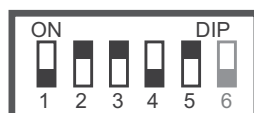

Code 30

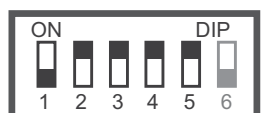

Code 07



Code 15



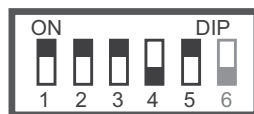

Code 23



Code 31



(*) Important:

- In door panel systems with call buttons, the first address on the monitor is 'Code 0'.
- In coded panel systems (N3301/GB2), 'Code 0' is 'Code 32', which means that when a call is made to a monitor with 'Code 0' (DIP 1 to DIP 5 set to OFF), it needs to be entered    on the N3301/GB2 numeric keypad.
- In the software (Address Manager GB2), 'Code 0' is also shown as 'Code 32'.

INSTALLING THE MONITOR IN A WALL MOUNTING CONNECTOR

Avoid dusty or smoky environments or locations near sources of heat.

Positioning the wall mounting connector:

The top of the connector must be positioned at a height of 1.60m. The minimum distance between the sides of the connector and the closest object must be 5cm.

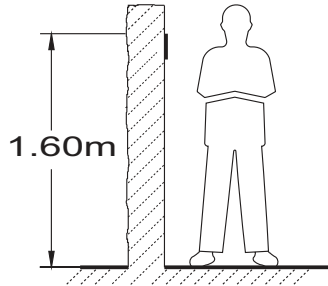

Fixing the monitor's wall mounting connector to the wall:

Fix the monitor's wall mounting connector to the wall by drilling two 6mm diameter holes and using the screws and plugs supplied with the monitor.

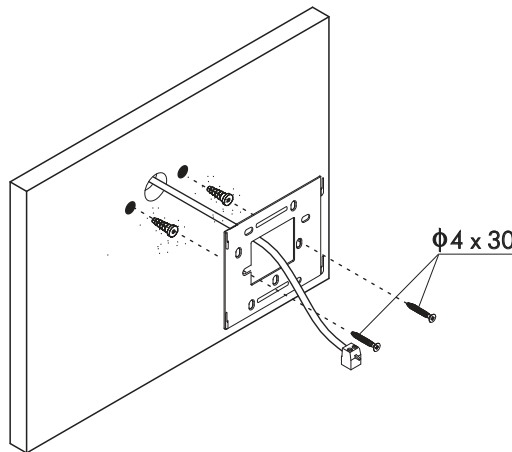

Positioning the monitor:

Connect the cables to the monitor (see p. 4), position the monitor in front of the wall mounting connector, ensuring that the holes in the base of the monitor line up with those on the connector ①, and then move the monitor downwards ② until the monitor is securely fixed to the connector ③.

Remember to remove the protective covering from the front of the monitor once installation is complete.

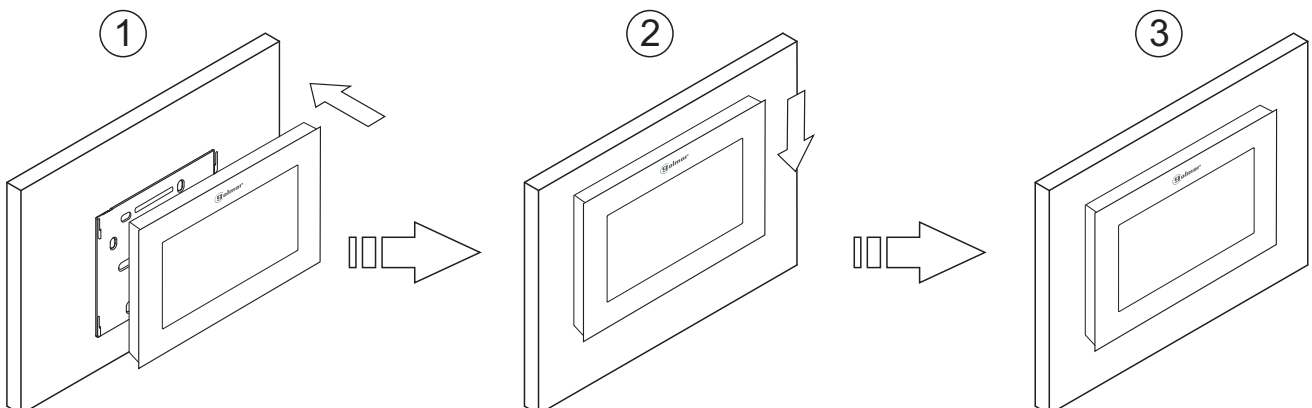

INSTALLING THE MONITOR IN AN EMBEDDING BOX

Avoid dusty or smoky environments or locations near sources of heat.

Positioning the embedding box:

Make a hole in the wall to position the top of the universal embedding box at a height of 1.60 m from the ground. The minimum distance between the sides of the embedding box and the closest object must be 5 cm.

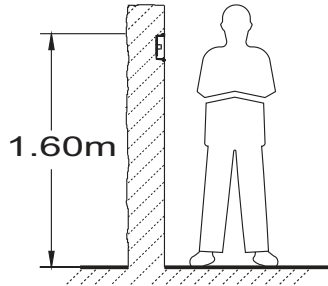

Positioning the embedding box and fitting the wall mounting connector:

Pass the cable through the hole made in the embedding box. Embed the box and ensure that it is level and flush. Fix the wall mounting connector of the monitor to the embedding box with the screws supplied.

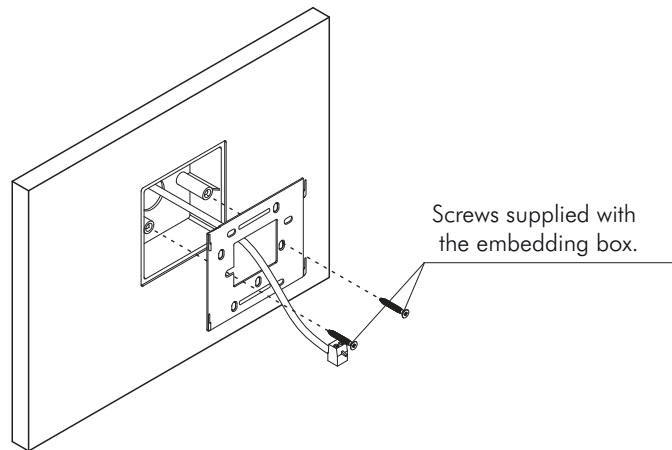

Positioning the monitor:

Connect the cables to the monitor (see p. 4), position the monitor in front of the wall mounting connector, ensuring that the holes in the base of the monitor line up with those on the connector ①, and then move the monitor downwards ② until the monitor is securely fixed to the connector ③.

Remember to remove the protective covering from the front of the monitor once installation is complete.

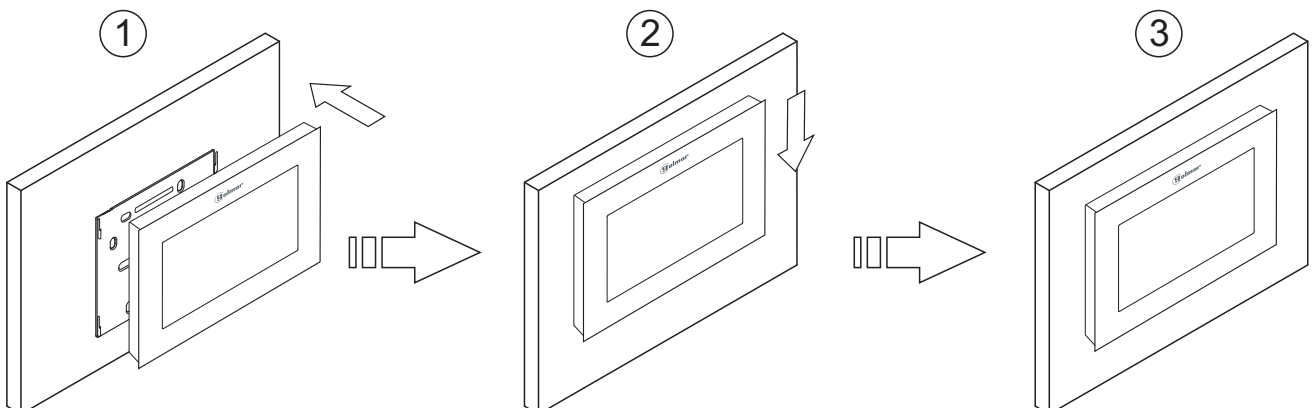

OPERATION

Monitor description when receiving a call and during communication:

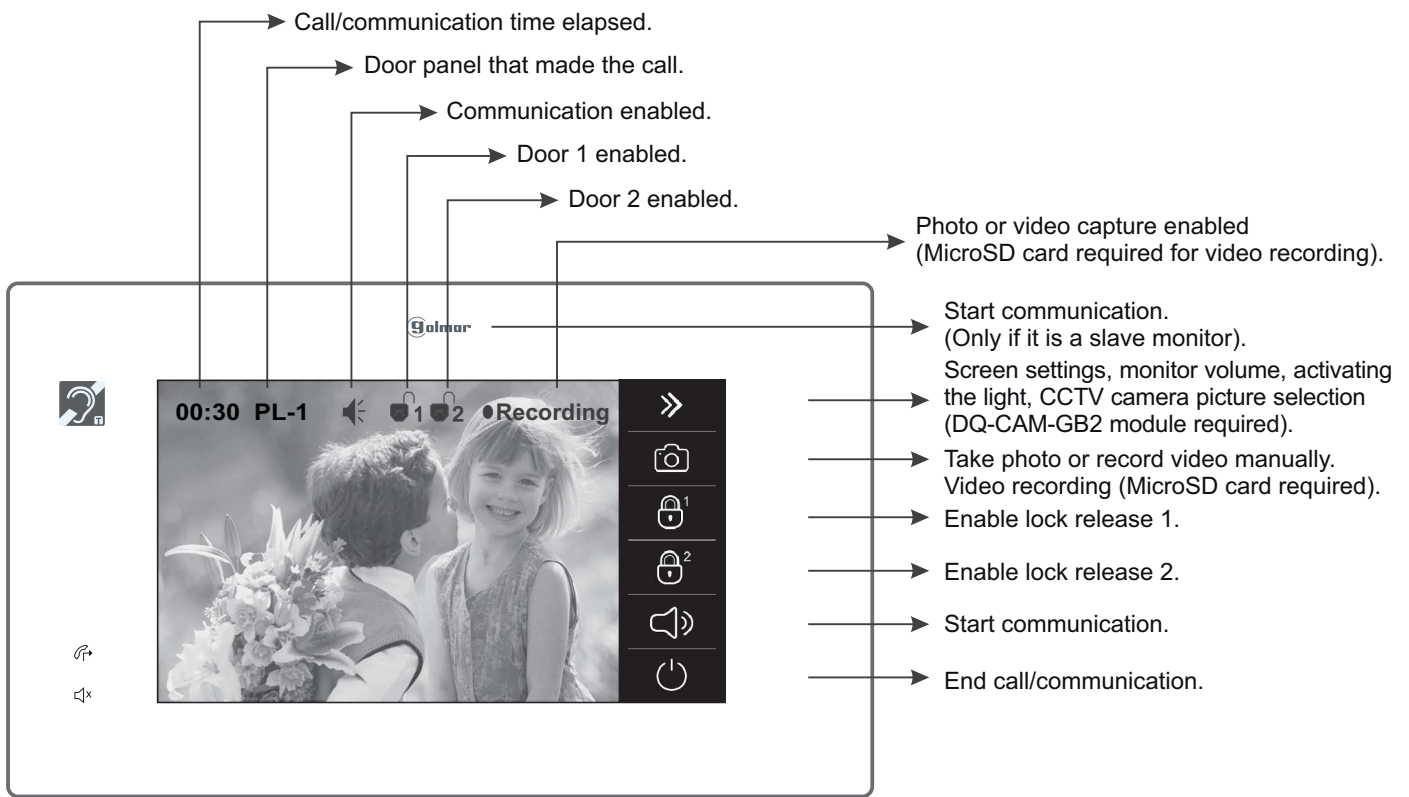

Communication with hearing aid (Pentha GB2/H monitor only):

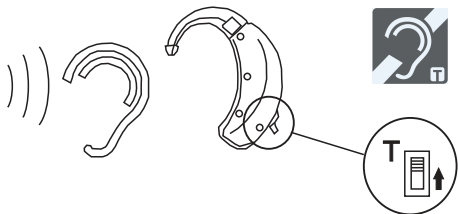

Make sure that the hearing aid is 15-25 cm away from the monitor to ensure maximum audio quality during communication with the door panel.

1.1 Receiving a call from the door panel:

When a call is received, the monitor(s) will play a melody, the status light of the monitor(s) will blink and show the image of the door panel on the main monitor without alerting the visitor. If the call is not answered within 40 seconds the monitor returns to standby mode.

The monitor automatically takes a photo or records a video (MicroSD card required for video).



- Screen settings, monitor volume, activating the light, CCTV camera picture selection (DQ-CAM-GB2 module required).
- Take photo or record video manually. Video recording (MicroSD card required).
- Enable lock release 1.
- Enable lock release 2.
- Start communication.
- End call/communication.

To open door 1, press the door release option on the screen during the call process: one press will activate the lock release for 5 seconds.

To open door 2, press the door release option on the screen during the call process: one press will activate the lock release for 5 seconds.

Continued overleaf

OPERATION

Continued from previous page.

1.2 Call not answered (missed call):

When a call is received, the monitor(s) will play a melody, the status light of the monitor(s) will blink and show the image of the door panel on the main monitor without alerting the visitor. If the call is not answered within 40 seconds the monitor returns to standby mode.

The monitor automatically takes a photo or records a video (MicroSD card required for video).



1.3 Ending a call from the door panel:

When a call is received, the monitor(s) will play a melody, the status light of the monitor(s) will blink and show the image of the door panel on the main monitor without alerting the visitor. To end the call, press option on the screen of the monitor.

To open door 1 or 2, press option / on the screen of the monitor during the call process: one press will activate the door release 1 or 2 for 5 seconds.



- To open door 1, press the door release option during the call or communication process: one press will activate the door release for 5 seconds.
- To open door 2, press the door release option during the call or communication process: one press will activate the door release for 5 seconds.
- End call.

1.4 Answering a call from the door panel:

When a call is received, the monitor(s) will play a melody, the status light of the monitor(s) will blink and show the image of the door panel on the main monitor without alerting the visitor. The monitor automatically takes a photo or records a video (MicroSD card required for video). To answer a call, press option on the master monitor screen or the logo on the front of any slave monitor in the apartment (unless the 'display image in call' function is activated on the slave monitor, in which case, option must be pressed). If the monitor is a PENTHA GB2/H with icon on the front, make sure that the hearing aid is 15 and 25 cm away from the monitor to ensure maximum audio quality during communication with the door panel.

Communication will last for 90 seconds or until option on the screen is pressed.

To open door 1 or 2, press option / on screen during the communication or call processes: one press will enable the lock release for 5 seconds.







- Start communication.
- To open door 1, press the door release option on the screen during the call process: one press will activate the lock release for 5 seconds.
- To open door 2, press the door release option on the screen during the call process: one press will activate the lock release for 5 seconds.
- End communication.

Continued overleaf



OPERATION

Continued from previous page.





1.5 Answering a call from the door panel (activating the light and displaying pictures from DQ-CAM-GB2 cameras):

When a call is received, the monitor(s) will play a melody, the status light of the monitor(s) will blink and show the image of the door panel on the main monitor without alerting the visitor. The monitor automatically takes a photo or records a video (MicroSD card required for video). To answer a call, press option  on the master monitor screen or the  logo on the front of any slave monitor in the apartment (unless the 'display image in call' function is activated on the slave monitor, in which case, option  must be pressed). If the monitor is a PENTHA GB2/H with icon  on the front, make sure that the hearing aid is 15 and 25 cm away from the monitor to ensure maximum audio quality during communication with the door panel.

Communication will last for 90 seconds or until option  on the screen is pressed.

To open door 1 or 2, press option  /  on screen during the communication or call processes: one press will enable the lock release for 5 seconds.



-  Start communication.
-  To open door 1, press the door release option during the call or communication process: one press will activate the door release for 5 seconds.
-  To open door 2, press the door release option during the call or communication process: one press will activate the door release for 5 seconds.
-  End communication.

During the communication process, the following functions can be performed:

→ Communication time elapsed (communication time of 90 seconds).

→ Door panel that made the call.

→ Communication enabled.

1st selection screen



→ Go to 2nd selection screen.

→ Take photo or record video manually from the door panel. Video recording (MicroSD card required).

→ Enable lock release 1 (relay 1 of the door panel).

→ Enable lock release 2 (relay 2 of the door panel).

→ End communication.

2nd selection screen



→ Go to 1st selection screen.

→ Activate external light (SAR-GB2 module required).

→ Adjust brightness, contrast, colour and communication volume (see pp. 12-13).

→ Adjust screen format (see pp. 12-13)

→ Select CCTV camera pictures, see p. 11. (DQ-CAM-GB2 module required)

→ Display image from door panel that made the call. (See p. 11).

OPERATION

Continued from previous page.

To display the picture from one of the installed cameras, press option **»»**. The following selection screen will be displayed. (DQ-CAM-GB2 camera module required).

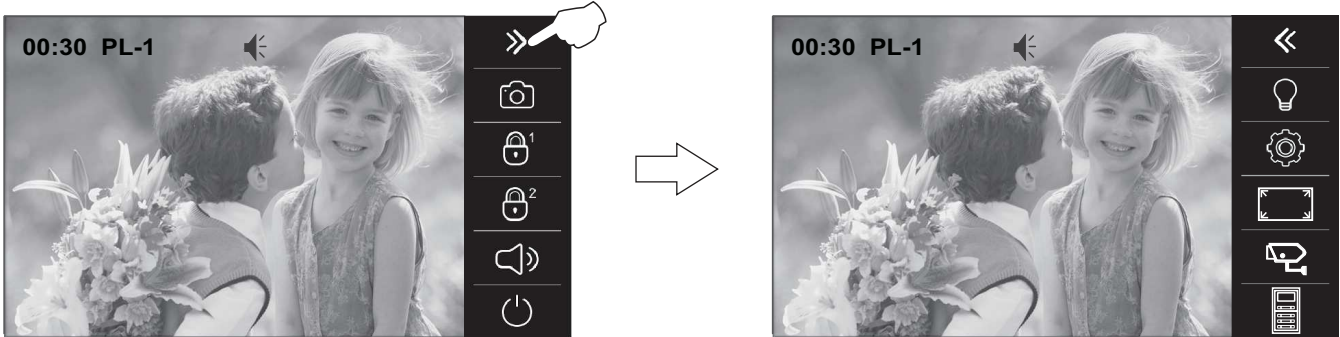

Then press option **☎**; the following camera selection screen will be displayed. Press the option corresponding to the 'CM' camera whose picture needs to be displayed.

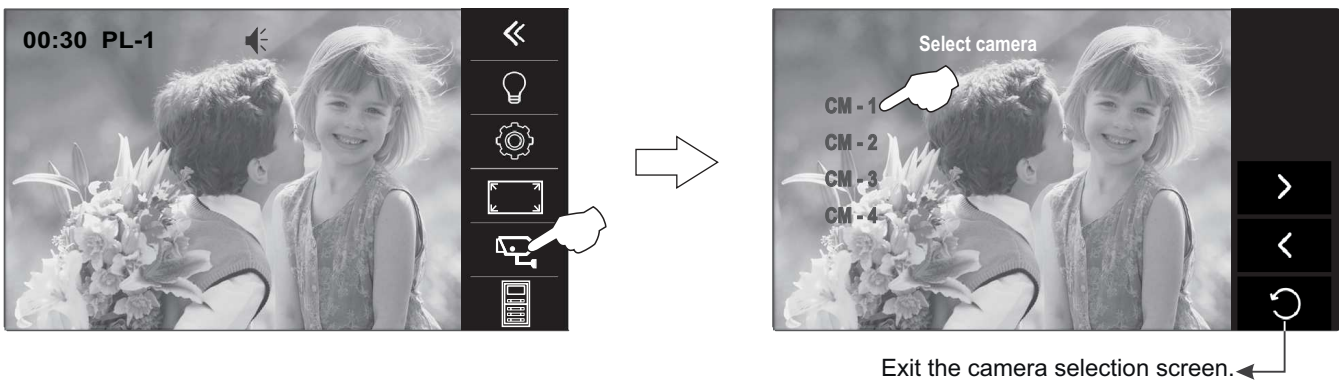



Then, by displaying the picture from camera 1 'CM - 1' selected and maintaining audio communication (with the door panel that made the call), the following functions can be performed:

<p>1st selection screen</p>	<ul style="list-style-type: none"> → Communication time elapsed (communication time of 90 seconds). → Picture from the camera selected. → Communication enabled (with the door panel that made the call).
<p>2nd selection screen</p>	<ul style="list-style-type: none"> → Go to 2nd selection screen. → Take photo or record video manually from the camera selected. Video recording (MicroSD card required). → Enable lock release 1 (relay 1 of the door panel in communication). → Enable lock release 2 (relay 2 of the door panel in communication). → End communication.
	<ul style="list-style-type: none"> → Go to 1st selection screen. → Activate external light (SAR-GB2 module required). → Adjust brightness, contrast, colour and communication volume (see pp. 12-13). → Adjust screen format (see pp. 12-13) → Select CCTV camera pictures. (DQ-CAM-GB2 module required) → Display image from door panel that made the call.

SCREEN AND VOLUME SETTINGS MENU

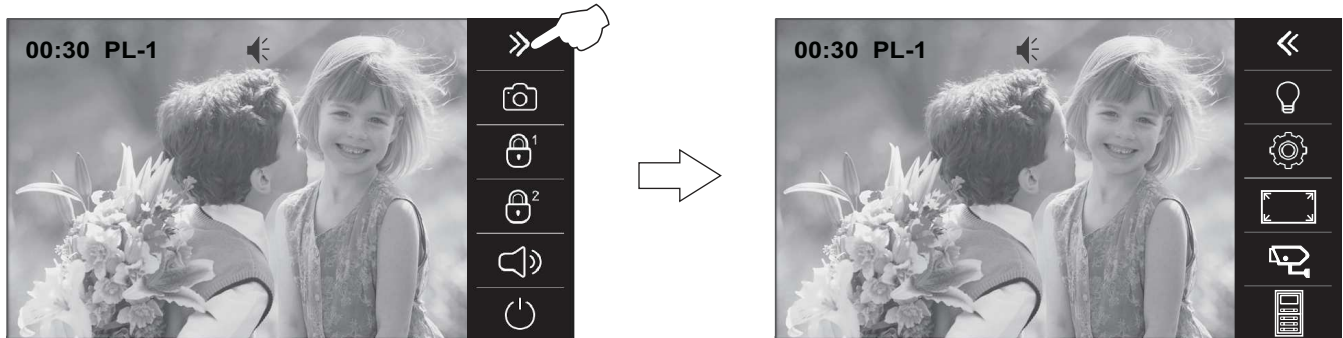





To access the screen and volume settings menu in the monitor, it must be in communication or auto switch-on mode. Then press option  and the 1st selection screen will be displayed.

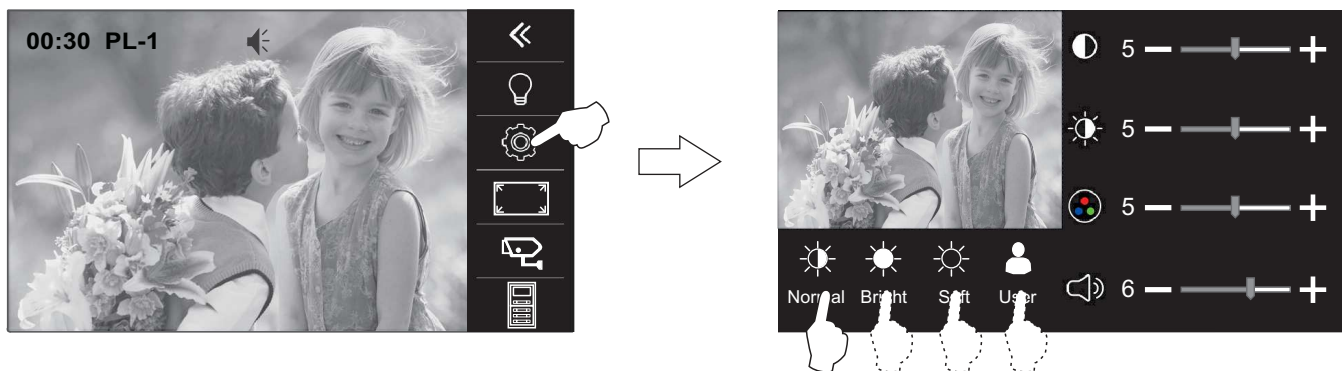

To access scene settings, press option . The following selection screen will be displayed; select the type of picture required (normal, bright, soft or user) by pressing the respective option. Press the door panel image shown on the screen to exit and return to the 1st selection screen.





1st selection screen

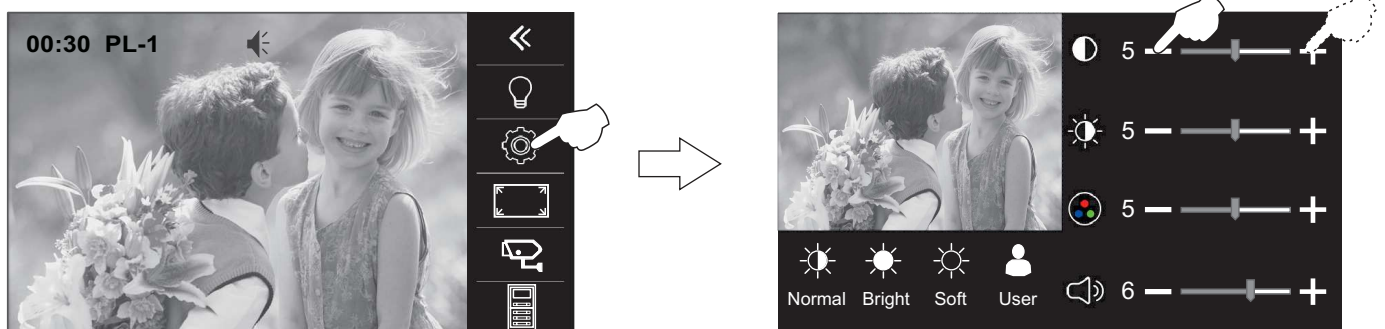

To access the brightness, contrast and colour settings, press option . The following selection screen will be displayed; press option  or  in each selection field to increase or decrease contrast , brightness  and colour . Press the door panel image shown on the screen to exit and return to the 1st selection screen.

1st selection screen



To access the monitor's volume setting, press option . The following selection screen will be displayed; press option  or  in selection  to increase or decrease the volume. Press the door panel image shown on the screen to exit and return to the 1st selection screen.

1st selection screen

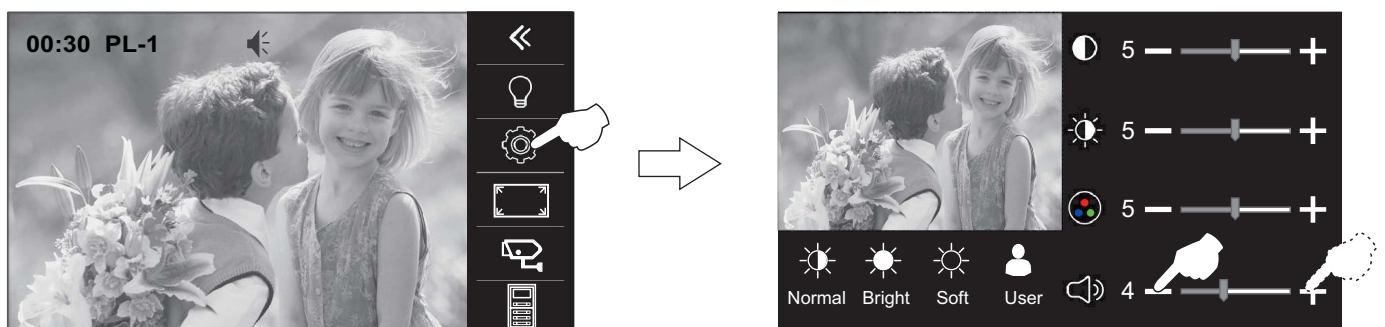

Continued overleaf

SCREEN AND VOLUME SETTINGS MENU

Continued from previous page.

To access the screen format setting, press option . The following selection screen will be displayed; select the type of screen format required by pressing the respective option.

1st selection screen



Press option  to exit and return to the 1st selection screen.

1st selection screen



Press option  to exit the screen and volume settings menu.

1st selection screen



Press option  to end communication or auto switch-on.

Monitor in standby



USER MENU

To access the menu, the monitor must be in standby. Then click on the screen or the **Golmar** logo on the front of the monitor. The main menu options screen will then appear.

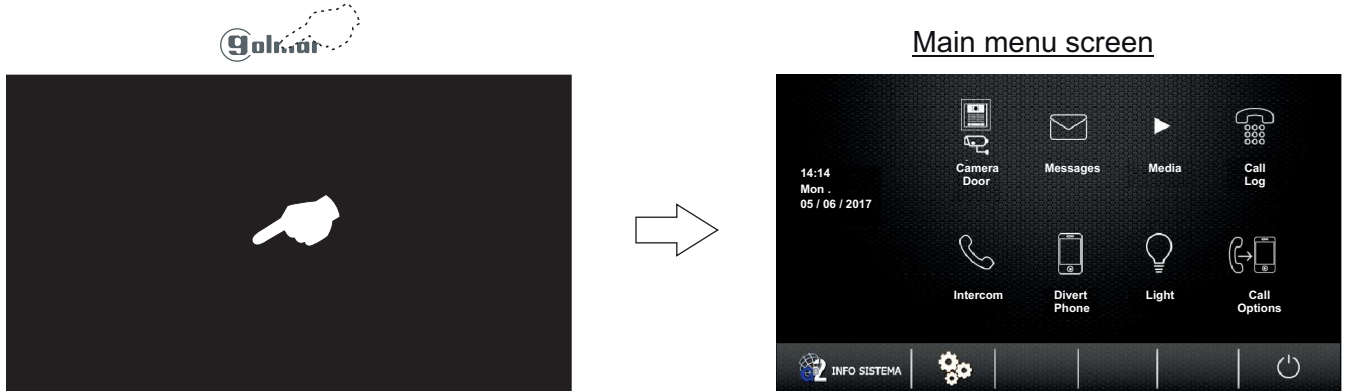

1.1 Displaying the main door panel image:

To display the main door panel image, press 'Camera / Door'. The following selection screen will be displayed. Press option 'PL - 1'.

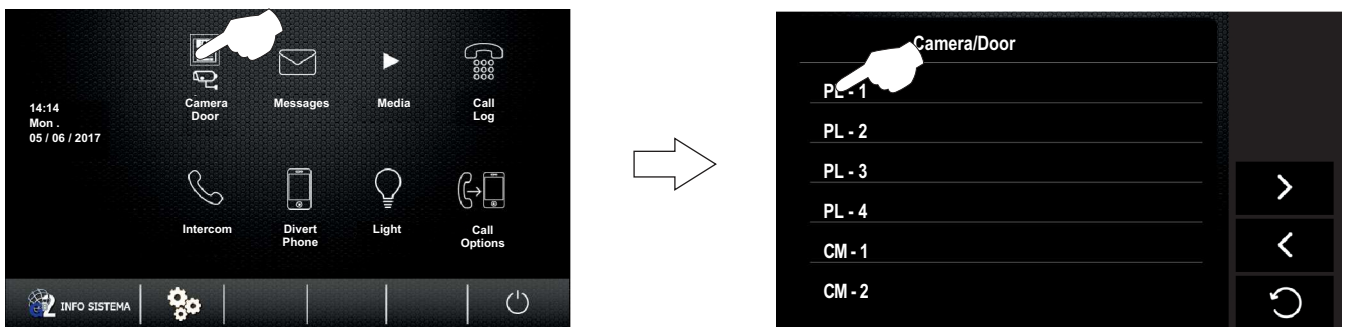

The following screen will display the image from the door panel with address 1, indicating the door panel selected 'PL-1' and the connection time elapsed. The connection will last for 30 seconds or until option is pressed.



- Screen settings, monitor volume, activating the light, CCTV camera picture selection (DQ-CAM-GB2 module required). (See settings pp. 12-13).
- Take photo or record video manually. Video recording (MicroSD card required).
- Enable lock release 1.
- Enable lock release 2.
- Start communication.
- End auto switch-on (return to the selection screen).

To open door 1, press the door release option on the screen during the picture display process: one press will activate the lock release for 5 seconds.

To open door 2, press the door release option on the screen during the picture display process: one press will activate the lock release for 5 seconds.

USER MENU

Continued from previous page.

To establish audio and video communication with the door panel selected, press option . The screen will display symbol . If the monitor is a PENTHA GB2/H with icon on the front, make sure that the hearing aid is between 15 and 25 cm away from the monitor to ensure maximum audio quality during communication with the door panel. Connection will last for 30 seconds or until option is pressed.

This symbol is only displayed in communication enabled mode.

- Screen settings, monitor volume, activating the light, CCTV camera picture selection (DQ-CAM-GB2 module required). (See settings pp. 12-13).
- Take photo or record video manually. Video recording (MicroSD card required).
- Enable lock release 1.
- Enable lock release 2.
- Start communication.
- End auto switch-on (return to the selection screen).

To open door 1, press the door release option on the screen during the communication process: one press will activate the lock release for 5 seconds.

To open door 2, press the door release option on the screen during the communication process: one press will activate the lock release for 5 seconds.

1.2 Displaying images from the door panels:

To display the image from one of the installed door panels, press 'Camera/Door'. The following selection screen will be displayed. Press the option corresponding to the 'PL' door panel whose image needs to be displayed.

The following screen will display the image from the door panel with address 2, indicating the door panel selected 'PL-2' and the connection time elapsed. The connection will last for 30 seconds or until option is pressed.

- Screen settings, monitor volume, activating the light, CCTV camera picture selection (DQ-CAM-GB2 module required). (See settings pp. 12-13).
- Take photo or record video manually. Video recording (MicroSD card required).
- Enable lock release 1.
- Enable lock release 2.
- Start communication.
- End auto switch-on (return to the selection screen).

To open door 1, press the door release option on the screen during the picture display process: one press will activate the lock release for 5 seconds.

To open door 2, press the door release option on the screen during the picture display process: one press will activate the lock release for 5 seconds.

Continued overleaf

USER MENU

Continued from previous page.

To establish audio and video communication with the door panel selected, press option . The screen will display symbol . If the monitor is a PENTHA GB2/H with icon on the front, make sure that the hearing aid is between 15 and 25 cm away from the monitor to ensure maximum audio quality during communication with the door panel. Connection will last for 30 seconds or until option is pressed.

This symbol is only displayed in communication enabled mode.

- Screen settings, monitor volume, activating the light, CCTV camera picture selection (DQ-CAM-GB2 module required). (See settings pp. 12-13).
- Take photo or record video manually. Video recording (MicroSD card required).
- Enable lock release 1.
- Enable lock release 2.
- Start communication.
- End auto switch-on (return to the selection screen).

To open door 1, press the door release option on the screen during the communication process: one press will activate the lock release for 5 seconds.

To open door 2, press the door release option on the screen during the communication process: one press will activate the lock release for 5 seconds.

1.3 Displaying camera pictures (DQ-CAM-GB2 module required):

To display the picture from one of the installed cameras, press 'Camera/Door'. The following selection screen will be displayed. Press the option corresponding to the 'CM' camera whose picture needs to be displayed.

Main menu screen

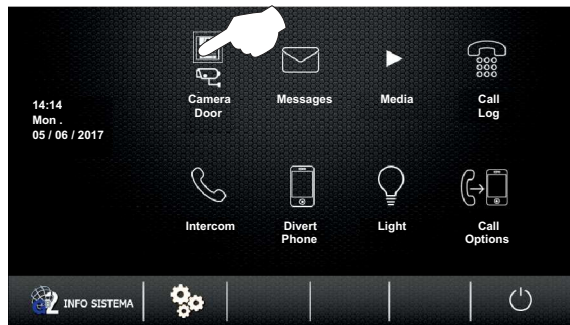

1st selection screen



2nd selection screen



- Press option to display the 2nd selection screen
- Press option to display the 1st selection screen
- Press option 'Quad-1'; the monitor will display the pictures from all of the cameras.
- Press option to return to the main menu screen.

USER MENU

Continued from previous page.

The following screen will then display the picture from the camera selected with address 4, indicating the camera selected 'CM-4' and the connection time elapsed.
The connection will last for 30 seconds or until option  is pressed.



- Screen settings, monitor volume, activating the light, CCTV camera picture selection (DQ-CAM-GB2 module required). (See settings pp. 12-13).
- Take photo or record video manually. Video recording (MicroSD card required).
- No function.
- No function.
- No function.
- End auto switch-on (return to the selection screen).

To exit and return to the main menu screen, press option .

1st selection screen



Main menu screen

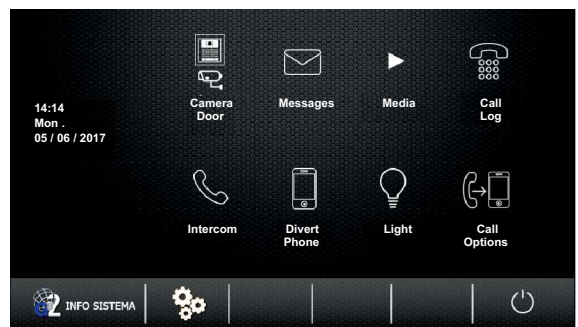

2.1 Text messages:

To access the text message functions, press option 'Messages'. The following selection screen will be displayed.

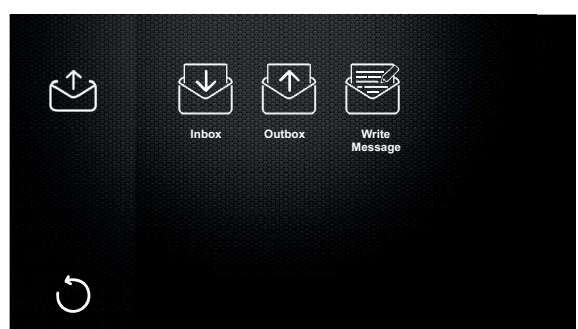
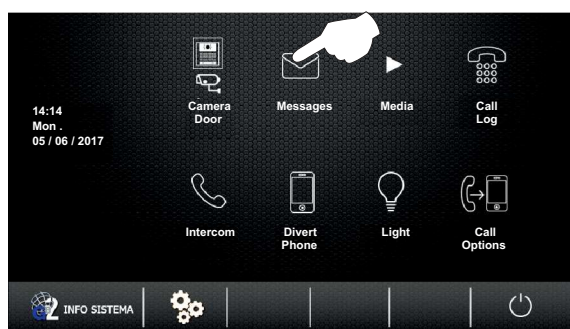

To send a text message, press option . The following recipient selection screen will be displayed.

Selection screen

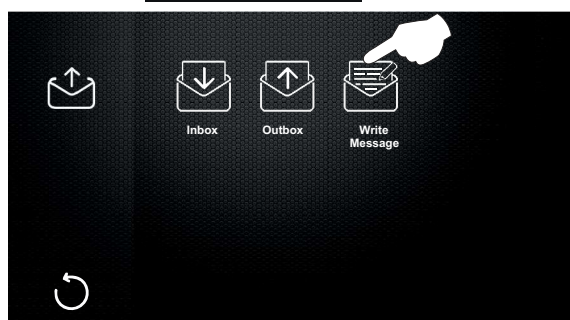

Recipient selection screen

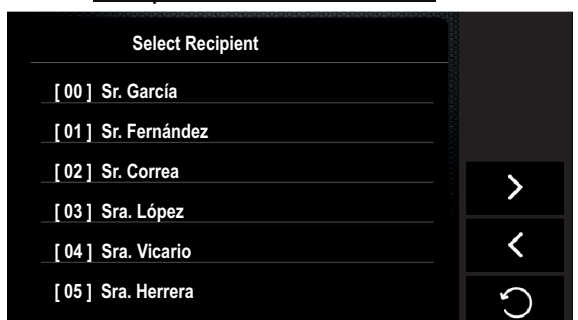

Continued overleaf

USER MENU

Continued from previous page.

Then press the apartment to which the text message needs to be sent.

Recipient selection screen

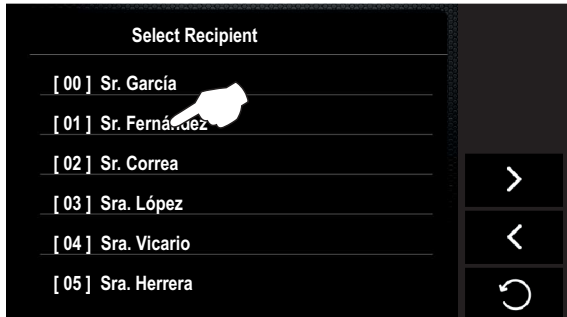

- Scroll forwards in the residents list.
- Scroll backwards in the residents list.
- Return to the selection screen.

The following screen will be displayed; use the keypad to enter the text message (up to 78 characters).

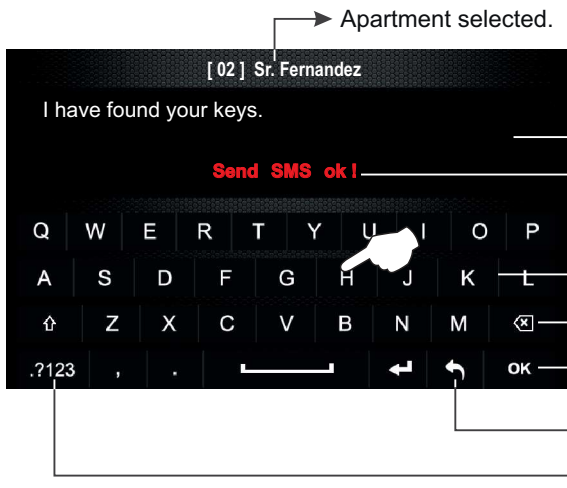

- Apartment selected.
- Screen (text message up to 78 characters).
- Message sent successfully.
- Alphabetical keypad.
- Key to delete characters.
- Key to send text message.
- Return to the recipient selection screen.
- Access the numeric keypad.

Press option ↶ to return to the recipient selection screen.

Then press option ↻ to go to the selection screen.

Recipient selection screen

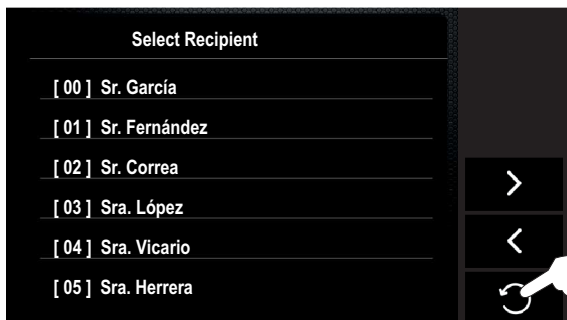

Selection screen

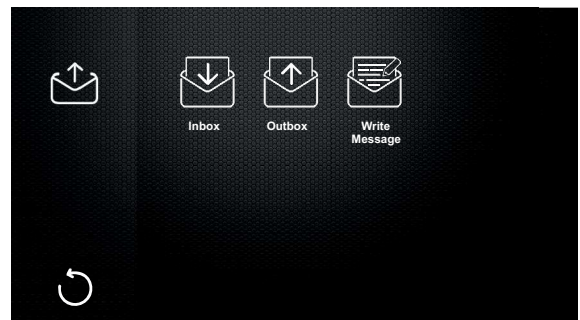

USER MENU

Continued from previous page.

To read text messages received, press option . The following text messages received screen will be displayed.

Icon  will indicate if any new messages have been received and the latest message(s) will be in red.

Selection screen



Messages received screen



Messages received screen



- Page 01 of a total of 03 pages is displayed.
- Access the recipient selection screen to write a text message (see pp. 17-18 'Text messages').
- Delete all messages received.
- Go to the next page.
- Go to the previous page.
- Return to the selection screen.

Then press the message that you want to read. The following screen will be displayed.

Messages received screen

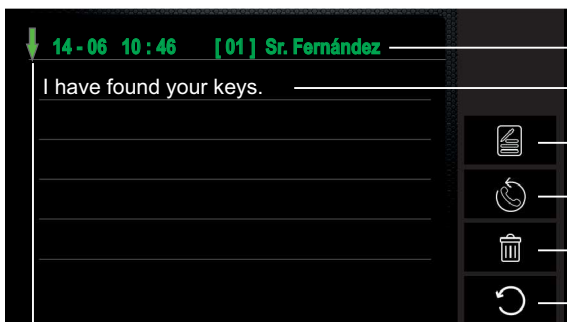

- Date / time and apartment sending the message.
- Message.
- Access the recipient selection screen to write a text message (see pp. 17-18 'Text messages').
- Make a call to the apartment that sent the text message.
- Delete this message.
- Return to the messages received screen.
- Down arrow ↓ indicates incoming text message.

Press option  to return to the messages received screen.

USER MENU

Continued from previous page.

Then press option  to go to the selection screen.

Messages received screen

Time Received	Name	01 / 03
14 - 06 10 : 46	[01] Sr. Fernández	
02 - 06 18 : 34	[03] Sra. López	
23 - 05 12 : 16	[00] Sr. García	
17 - 05 08 : 33	[02] Sr. Correa	
11 - 04 17 : 25	[04] Sra. Vicario	
05 - 03 21 : 10	[05] Sra. Herrera	

Selection screen

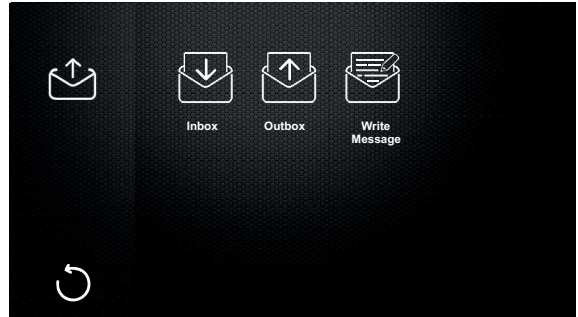

To read text messages sent, press option . The following text messages sent screen will be displayed.

Selection screen

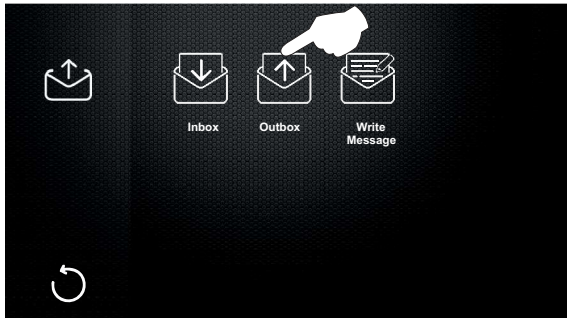

Messages sent screen

Time Sent	Name	01 / 03
14 - 06 10 : 46	[01] Sr. Fernández	
02 - 06 18 : 34	[03] Sra. López	
23 - 05 12 : 16	[00] Sr. García	
17 - 05 08 : 33	[02] Sr. Correa	
! 11 - 04 17 : 25	[04] Sra. Vicario	
05 - 03 21 : 10	[05] Sra. Herrera	

Messages sent screen

Time Sent	Name	01 / 03
14 - 06 10 : 46	[01] Sr. Fernández	
02 - 06 18 : 34	[03] Sra. López	
23 - 05 12 : 16	[00] Sr. García	
17 - 05 08 : 33	[02] Sr. Correa	
! 11 - 04 17 : 25	[04] Sra. Vicario	
05 - 03 21 : 10	[05] Sra. Herrera	

- Page 01 of a total of 03 pages is displayed.
- Access the recipient selection screen to write a text message (see pp. 17-18 'Text messages').
- Delete all messages sent.
- Go to the next page.
- Go to the previous page.
- Return to the selection screen.

! indicates error in text message sent (e.g. apartment without Pentha monitor).

Then press the message sent that you want to read. The following screen will be displayed.

Messages sent screen

Time Received	Name	01 / 03
14 - 06 10 : 46	[01] Sr. Fernández	
02 - 06 18 : 34	[03] Sra. López	
23 - 05 12 : 16	[00] Sr. García	
17 - 05 08 : 33	[02] Sr. Correa	
! 11 - 04 17 : 25	[04] Sra. Vicario	
05 - 03 21 : 10	[05] Sra. Herrera	



USER MENU

Continued from previous page.

↑ 14 - 06 10 : 46 [01] Sr. Fernández → Date / time and apartment to which the message is being sent.

I have found your keys. → Message.

[Document with pencil icon] → Access the recipient selection screen to write a text message (see pp. 17-18 'Text messages').

[Telephone handset icon] → Make a call to the apartment that sent the text message.

[Trash bin icon] → Delete this message.

[Circular arrow icon] → Return to the messages sent screen.

↑ indicates text message sent.

Press option ↻ to return to the messages received screen.

Then press option ↻ to go to the selection screen.

Messages received screen

Time Received	Name	01 / 03	
14 - 06 10 : 46	[01] Sr. Fernández		[Document with pencil icon]
02 - 06 18 : 34	[03] Sra. López		[Trash bin icon]
23 - 05 12 : 16	[00] Sr. García		[Right arrow icon]
17 - 05 08 : 33	[02] Sr. Correa		[Left arrow icon]
! 11 - 04 17 : 25	[04] Sra. Vicario		[Circular arrow icon]
05 - 03 21 : 10	[05] Sra. Herrera		



Selection screen

To exit and return to the main menu screen, press option ↻.

Selection screen



Main menu screen

USER MENU

Continued from previous page.

3.1 Viewing photos and videos of door panel calls, cameras and deleting photos and videos:

Note: The monitor enables photos to be taken as standard. For the video option, a MicroSD card is required. Use of this card cancels the photo option.

To access the photo or video viewing functions, press option 'Media'. The following selection screen will be displayed.

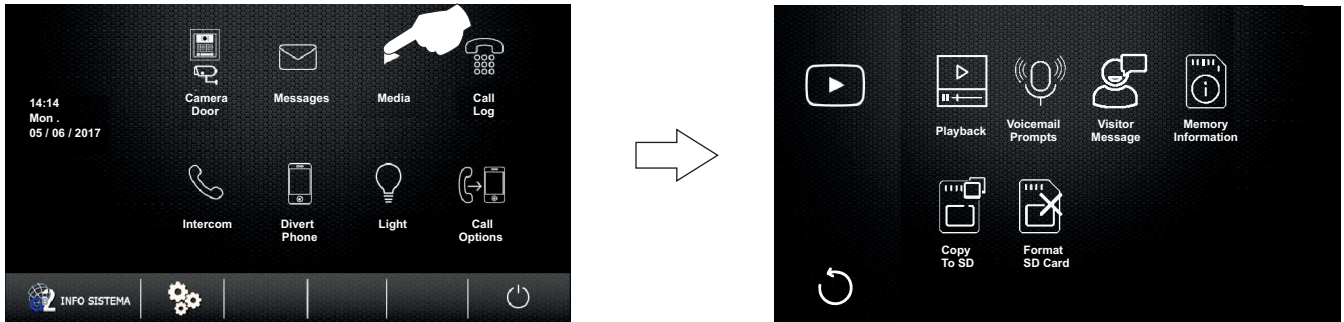

To view photos or play back videos from calls/cameras, press option . The following selection screen will be displayed; use options > and < to select the photo or video to be viewed. If the MicroSD card is being used, the length of each video is 10 seconds. Option || enables the video to be played or paused.

Selection screen

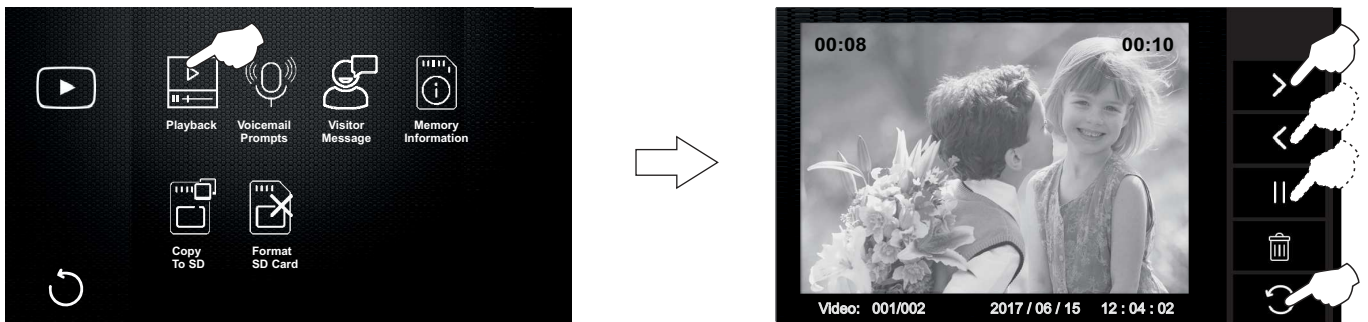

To delete photos or videos, use options > and < to select the photo or video to be deleted and then press option to bring up the following deletion screen. Press option to delete the photo or video selected or press option to exit without deleting and return to the previous screen.

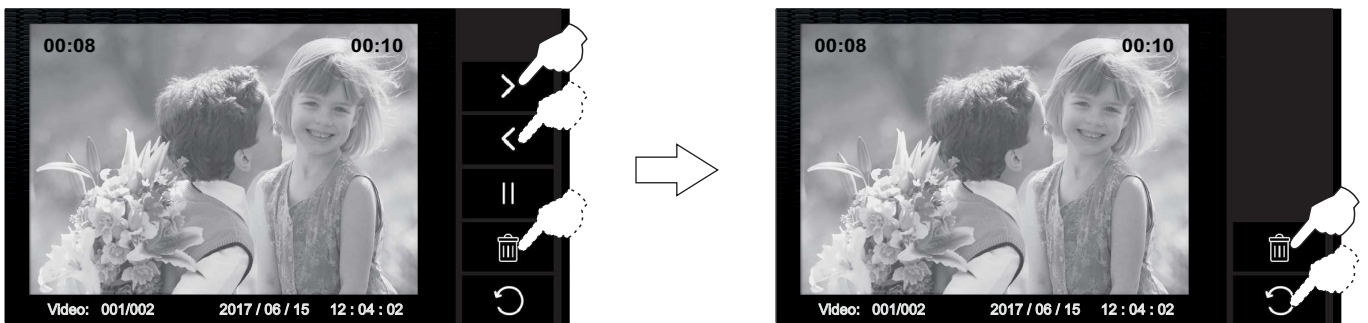

Press option to return to the selection screen.

Selection screen

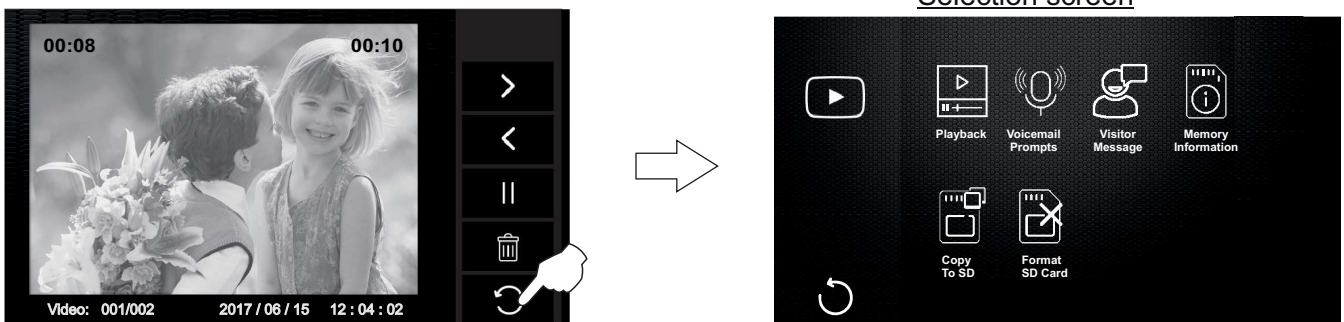

USER MENU

Continued from previous page.

3.2 Voicemail prompts (no function).

Selection screen



3.3 Visitor messages (no function).

Selection screen

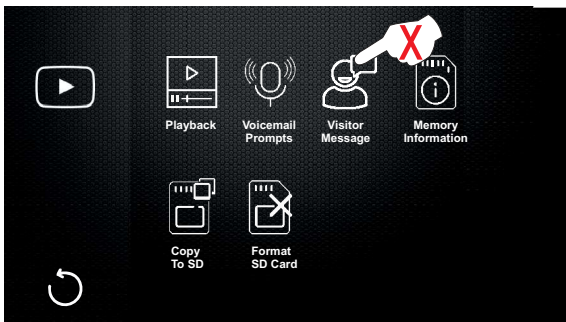

3.4 To access the MicroSD card information, press option . The following information screen will be displayed. Note that the monitor has a flash memory for photos but, if video recording is required, a MicroSD card must be inserted.

Selection screen

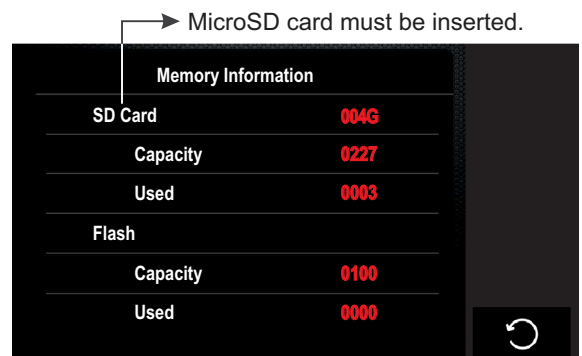
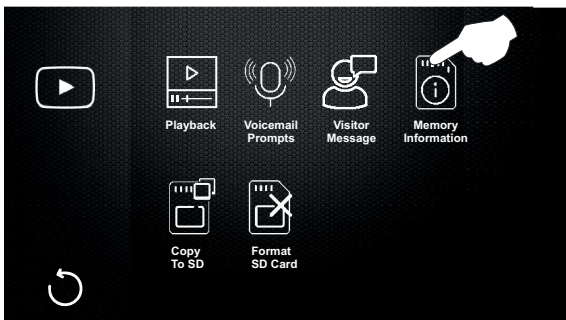

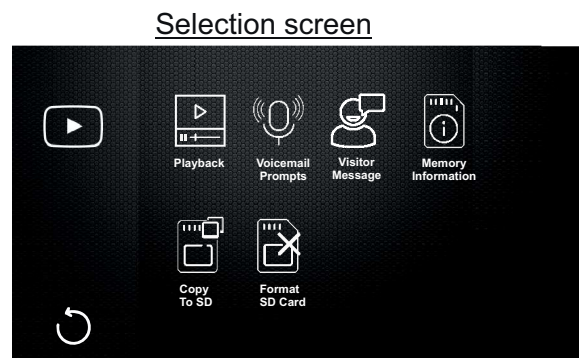
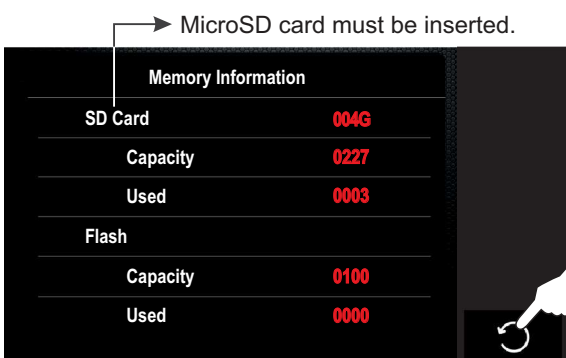

Press option  to return to the selection screen.





USER MENU

Continued from previous page.

3.5 To copy photos from the flash memory to the MicroSD card, press option . The following screen will be displayed. Press option  to copy photos to the MicroSD card or option  to cancel and return to the selection screen.

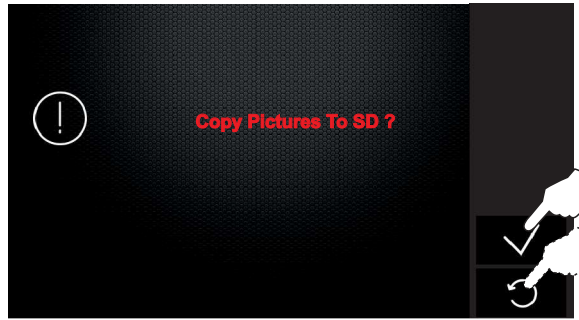
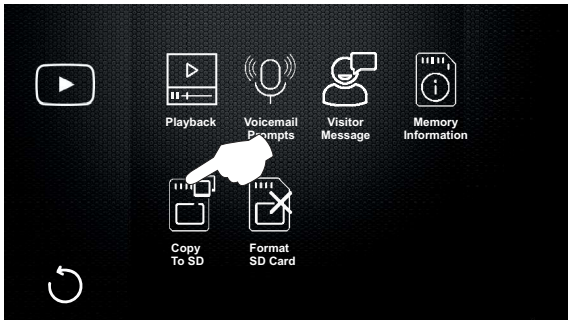
Selection screen



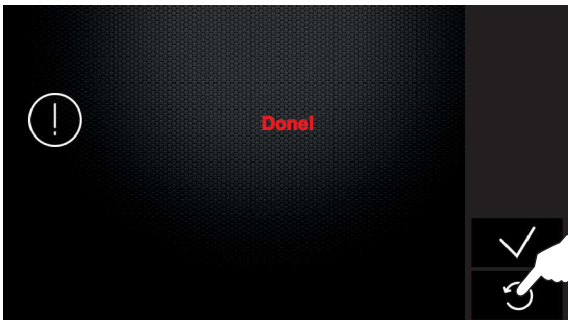

Press option  to return to the selection screen.



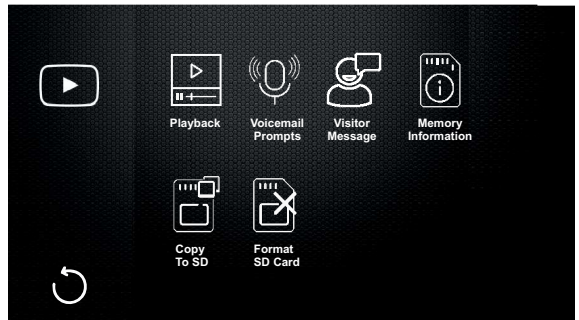

Selection screen

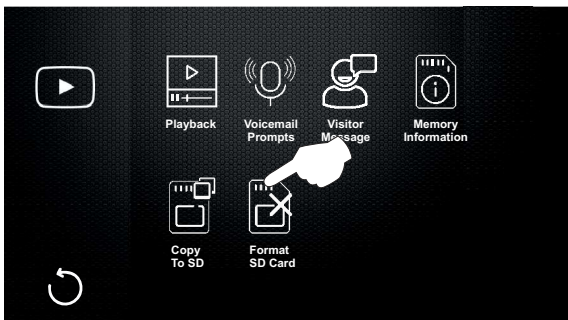

3.6 To format the MicroSD card, press option . The following screen will be displayed. Press option  to format the MicroSD card or option  to cancel and return to the selection screen.

Selection screen



To return to the main menu after formatting the MicroSD card, press the screen or the  logo on the front of the monitor. The main menu options screen will then appear.

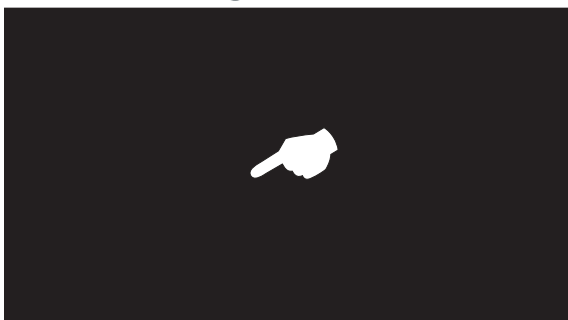

Main menu screen

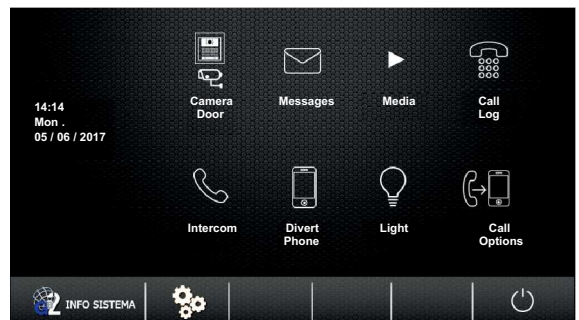

Continued overleaf

USER MENU

Continued from previous page.

4.1 Viewing the call log:

To view the call log, press option 'Call Log'. The following screen will be displayed.

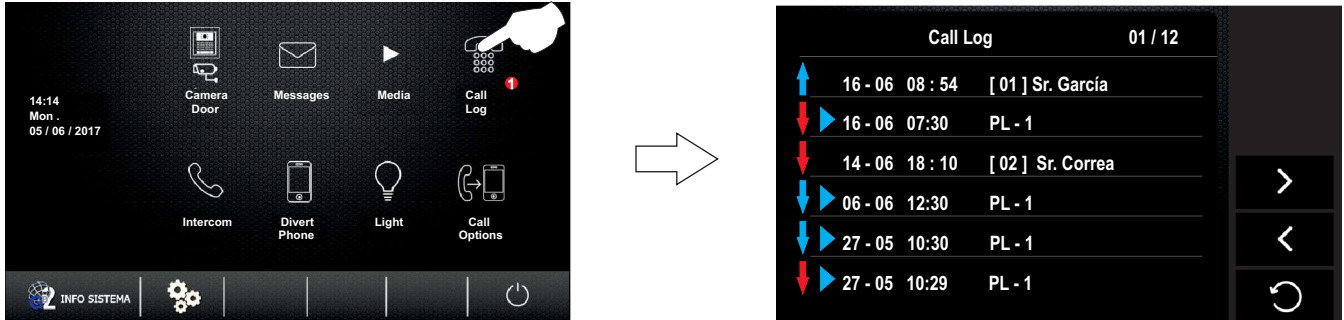

'Call Log' screen description.

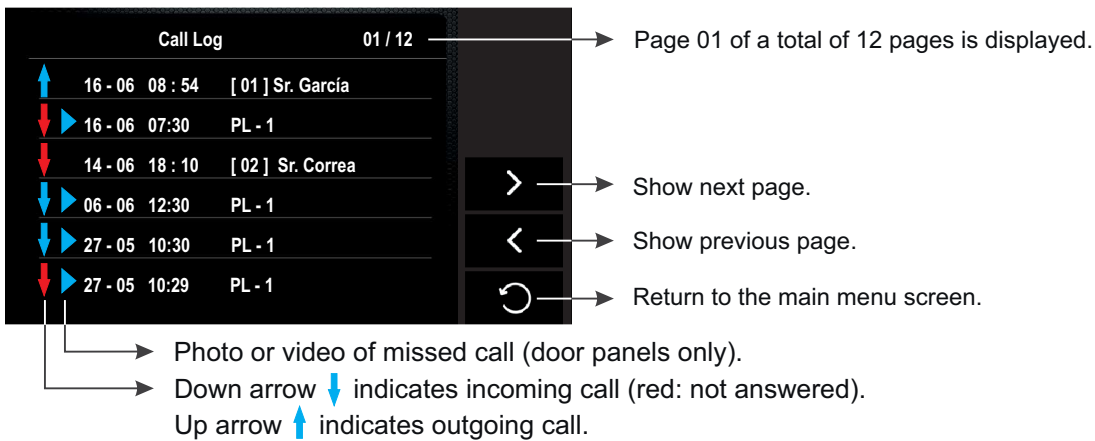

If a door panel call log entry is pressed.

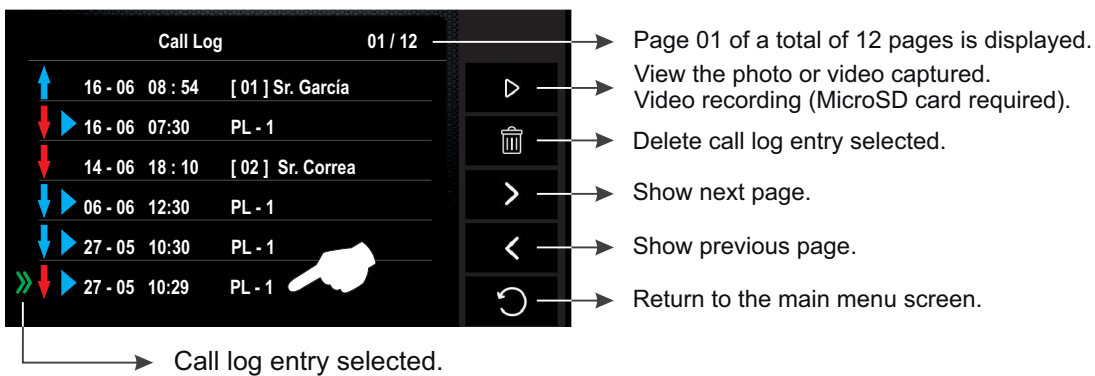

If an intercom call log entry from an apartment is pressed.

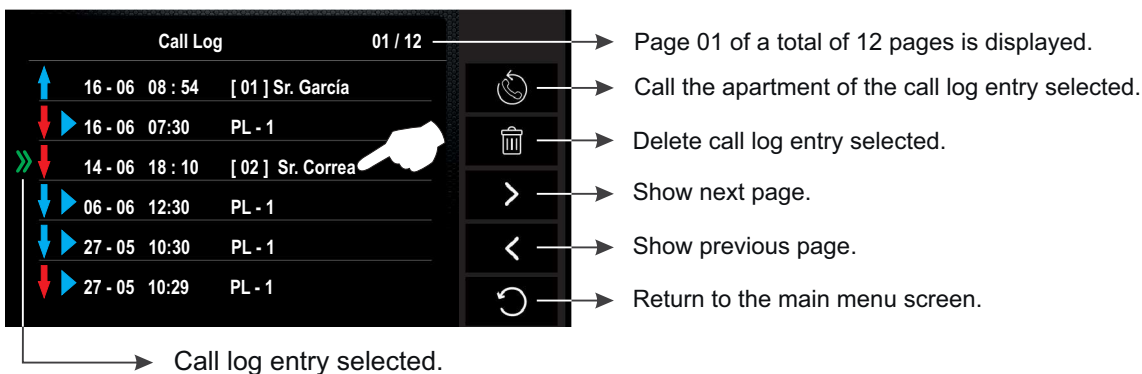

USER MENU

Continued from previous page.

5.1 Intercom (internal broadcast):

To access the internal broadcast function, press option 'Intercom'. The following selection screen will be displayed; press option 'Internal Broadcast'.

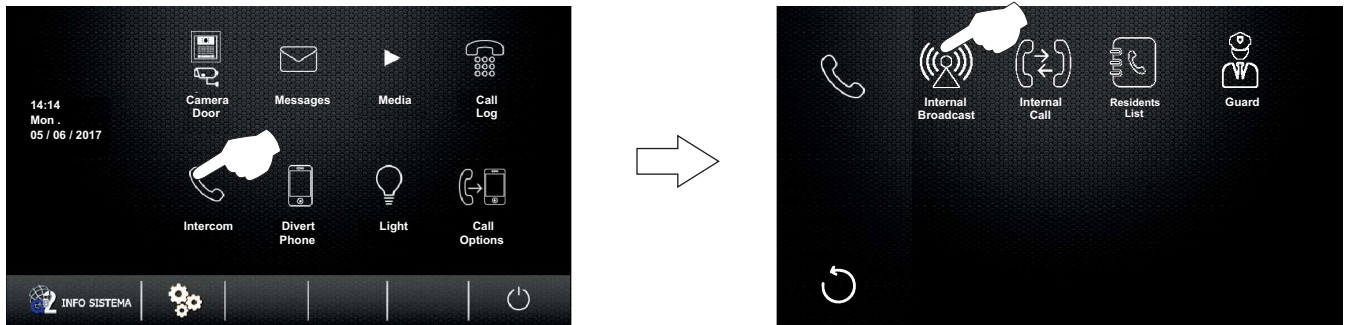

The following communication screen will be displayed (the other monitors do not display any communication screens). It is now possible to talk and listen to the other monitors in the apartment from each of the monitors. Communication will last for one and a half minutes or until option is pressed from the monitor that has performed the broadcast function.

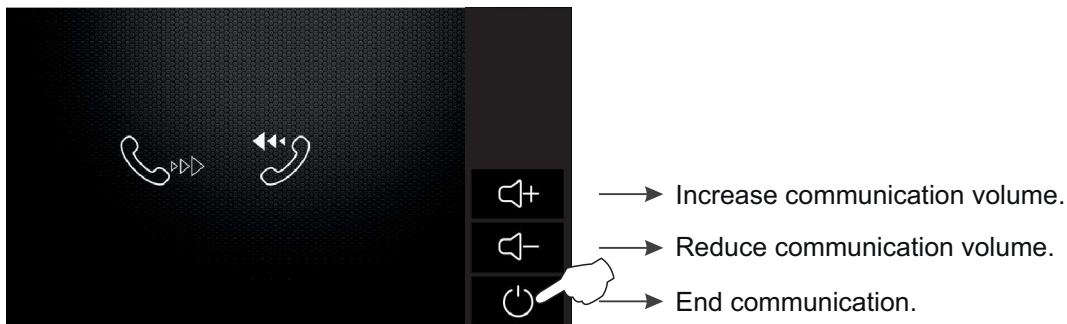

If a call is received from the door panel during the internal broadcast process, the intercom call will be cancelled; a melody in the apartment's monitors will play to indicate that a call is being made and an image will appear on the master monitor. To establish communication, press option on the master monitor screen or the logo on the front of any slave monitor in the apartment (unless the 'display image in call' function is enabled on the slave monitor, in which case, option must be pressed).

If a call is received from another apartment during the internal broadcast process, the intercom call will be cancelled; a melody in the apartment's monitors will play to indicate that a call is being made and the call screen and the address of the apartment making the intercom call will appear on the master monitor (see 'intercom calls between apartments' on p. 28).

USER MENU

Continued from previous page.

5.2 Intercom calls within the same apartment:

To access the intercom calls within the same apartment function, press option 'Intercom'. The following selection screen will be displayed; press option 'Internal Call'.

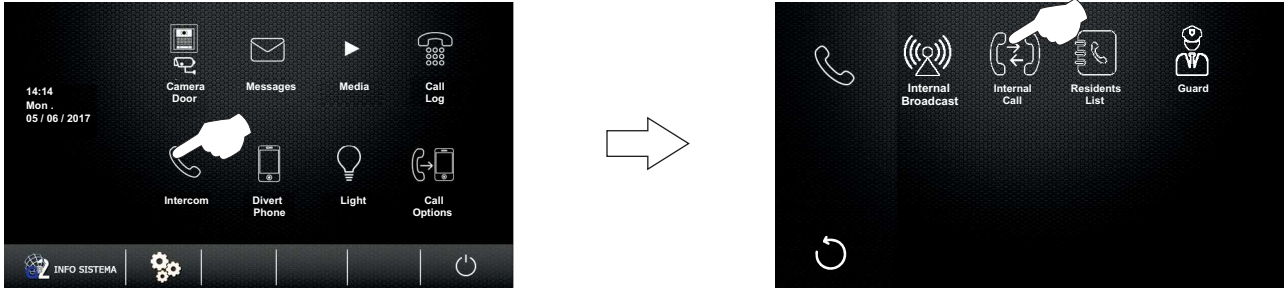

The following call screen will appear and a melody in the other monitors of the apartment will play to indicate the presence of the intercom call. The call will end if it is not answered within 40 seconds or if option is pressed.

Make an intercom call

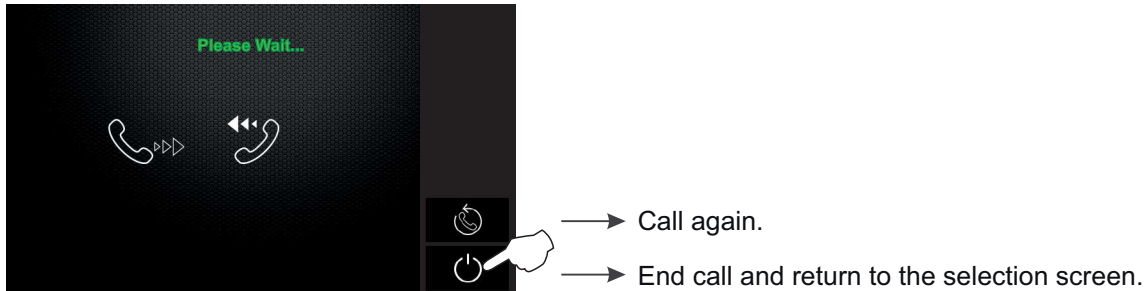

Press button to accept the call and establish communication or press option to end the call.

Receive an intercom call

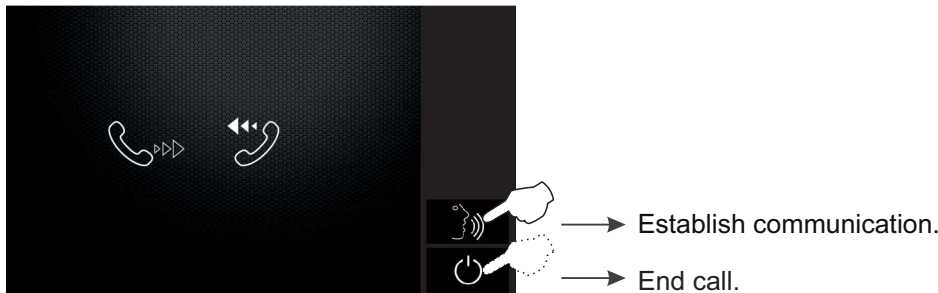

If the call is accepted, communication will last for 90 seconds or until option is pressed.

In communication

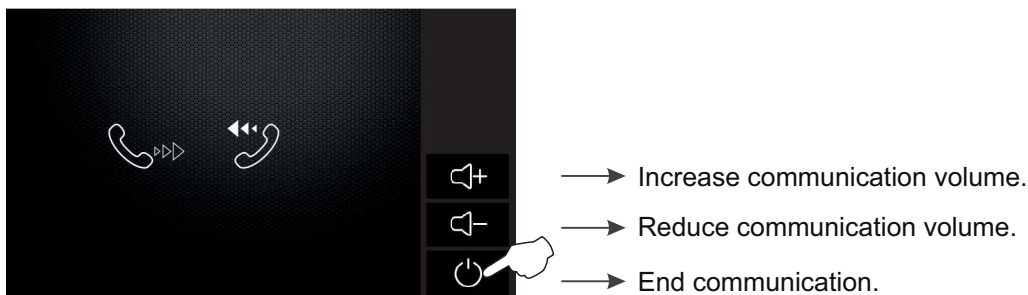

If a call is received from the door panel during the intercom process, the intercom call will be cancelled; a melody in the apartment's monitors will play to indicate that a call is being made and an image will appear on the master monitor. To establish communication with the door panel, press option on the master monitor or the on the front of any slave monitor in the apartment (unless the 'display image in call' function is enabled on the slave monitor, in which case, option must be pressed).

Continued overleaf

USER MENU

Continued from previous page.

5.3 Intercom calls between apartments:

To access the intercom calls between apartments function, press option 'Intercom'. The following selection screen will be displayed; press option 'Residents List'.

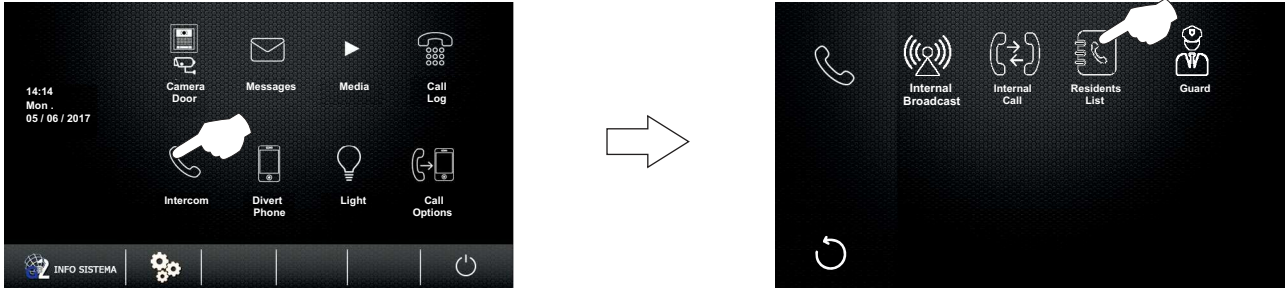

The following apartment selection screen will be displayed. Press the apartment to be called. Then press option to make the call.

Apartment selection screen

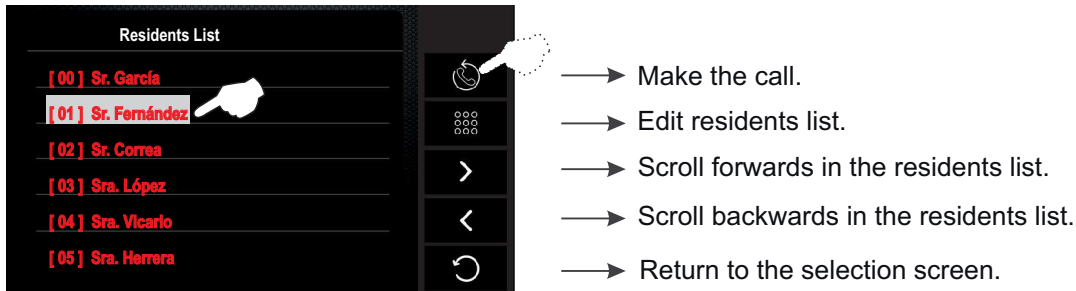

The following call screen will be displayed indicating the address and name of the apartment to be called. In the monitor(s) of the apartment called, a melody will play indicating the presence of an intercom call and the address and name of the apartment making the call will be displayed on the master monitor. The call will end if it is not answered within 40 seconds or if option is pressed.

Make an intercom call

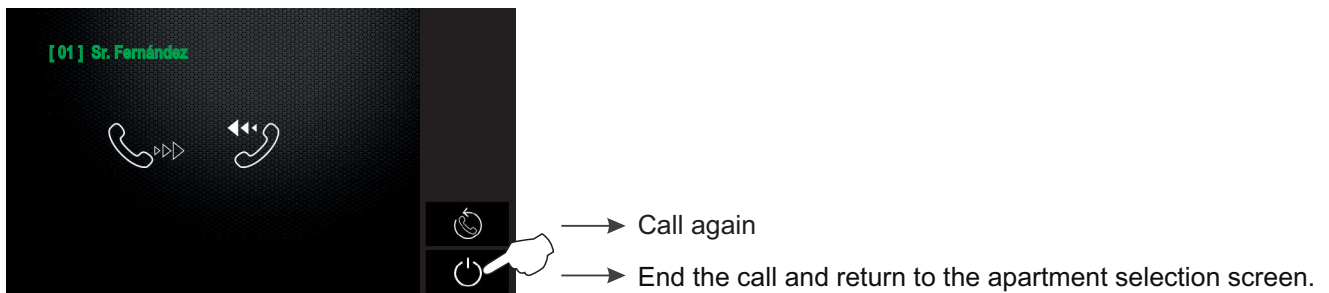

To accept the call, press option on the master monitor screen or the logo on the front of any slave monitor and establish communication. Press option to end the call.

Receive an intercom call

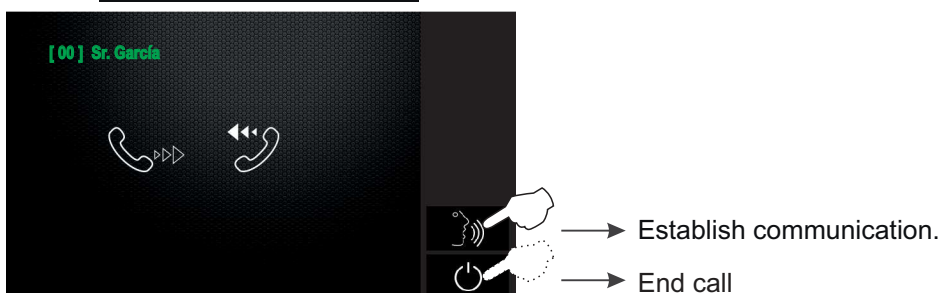





USER MENU

Continued from previous page.

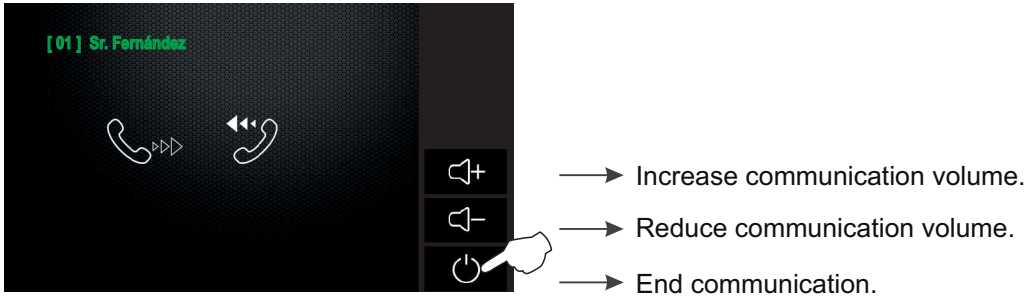
If the call is accepted, communication will last for 90 seconds or until option  is pressed.

In communication



If a call is received from the door panel of another apartment during the intercom process, the intercom call will be cancelled; the monitors in the apartment will play a melody indicating that the call is being made and the image will appear on the master monitor. To establish communication with the door panel, press option  on the master monitor or the  logo on the front of any slave monitor in the apartment (unless the 'display image in call' function is enabled on the slave monitor, in which case, option  must be pressed).

USER MENU

Continued from previous page.

5.4 Call to guard monitor:

To access the call to guard monitor function (if the building has one), press option 'Intercom'. The following selection screen will be displayed; press option 'Guard'.

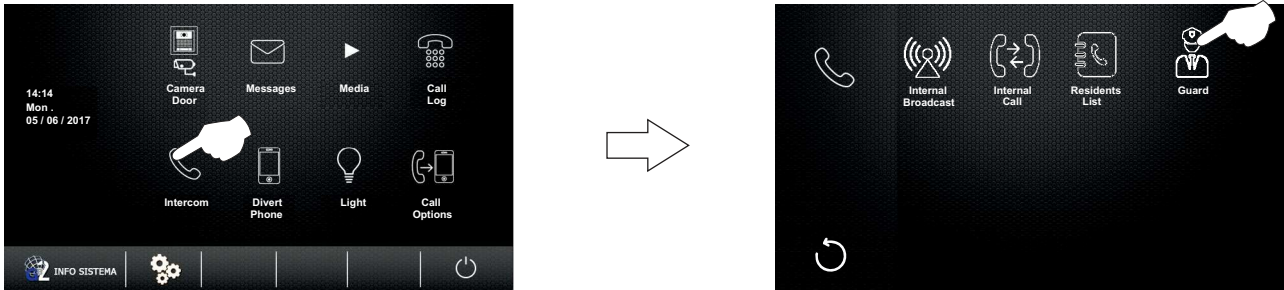

The following call screen will be displayed and a melody will play, indicating the 'GU' address of the guard monitor to be called. The call will end if it is not answered within 40 seconds or if option is pressed.

Make an intercom call

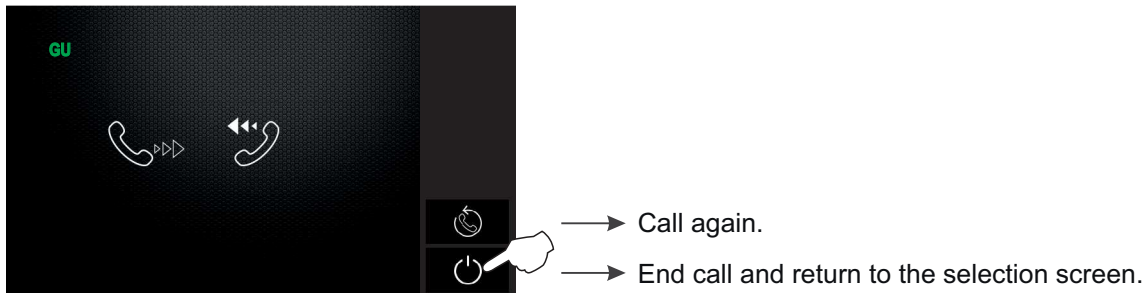

To accept the call, press option on the guard monitor screen and establish communication or press option to end the call.

Receive an intercom call

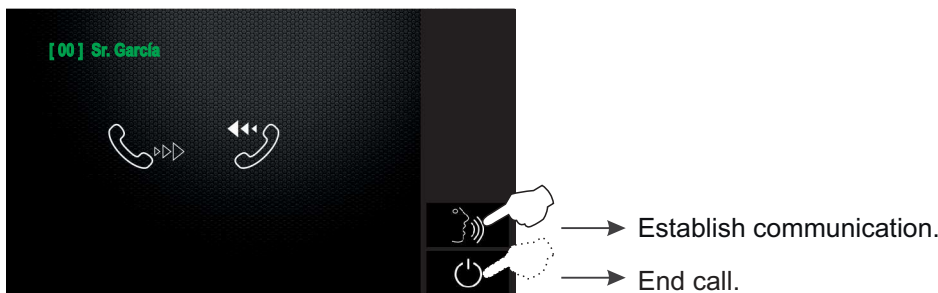

If the call is accepted, communication will last for 90 seconds or until option is pressed.

In communication

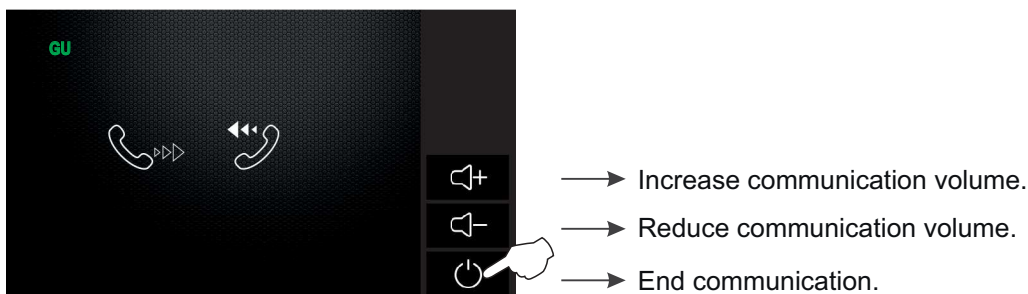

If a call is received from the door panel of another apartment during the intercom process, the intercom call will be cancelled; the monitors in the apartment will play a melody indicating that the call is being made and the image will appear on the master monitor. To establish communication with the door panel, press option on the master monitor or the logo on the front of any slave monitor in the apartment (unless the 'display image in call' function is enabled on the slave monitor, in which case, option must be pressed).

Continued overleaf

USER MENU

Continued from previous page.

6.1 Configuring divert call phone numbers:

To access divert call phone number configuration, press option 'Divert Phone'. The following selection screen will be displayed; press option 'Divert Numbers'.

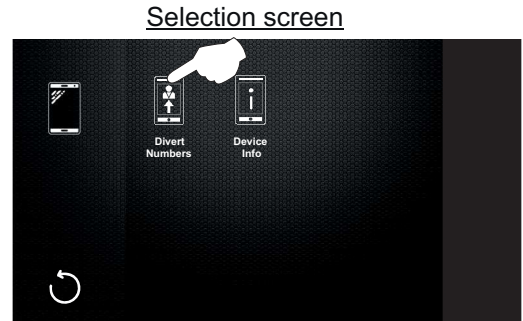
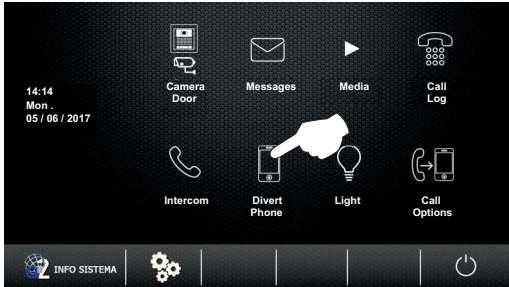

The following phone number settings screen will be displayed; press option 'Tel 1'. The following phone number editing screen will be displayed; enter the phone number with the numeric buttons. To save, press option 'OK'; on the settings screen, press option [Save icon]; and then, to exit, press option [Back icon]. To exit without saving, press option [Cancel icon] and, on the settings screen, press option [Cancel icon]. From the settings screen, to enter a 2nd and 3rd divert call phone number, press the options ('Tel 2', 'Tel 3') and repeat the number editing steps from option 'Tel 1'.

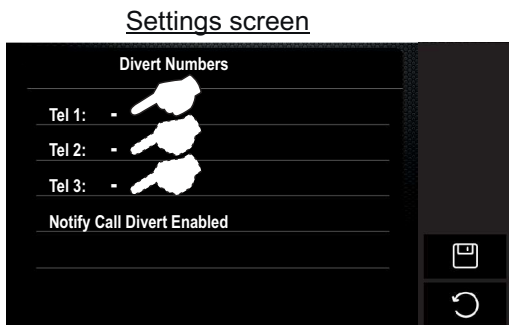

The following settings screen will then be displayed with the phone number(s) now edited. Press option 'Notify Call Divert Enabled' and the mobile phones configured will receive an SMS message indicating that the phone number is linked to the apartment's divert call function. Press option [Back icon] to exit.

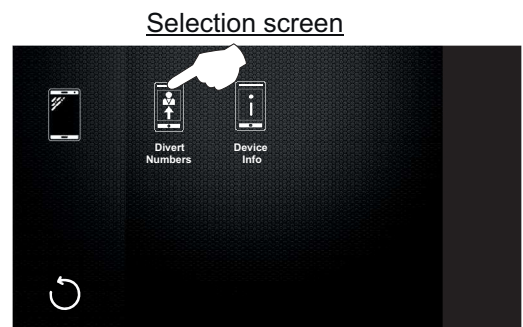
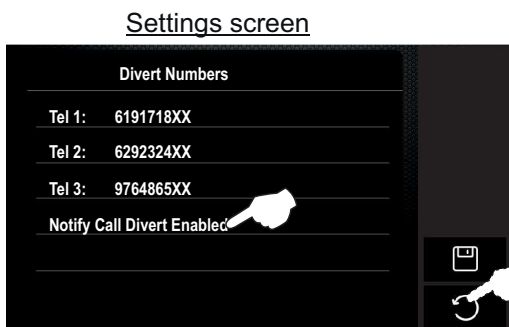

Press option [Back icon] to exit and return to the main menu screen.

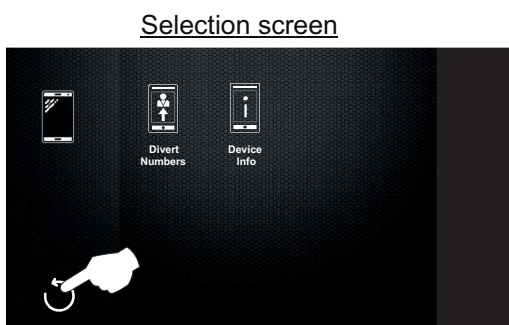



USER MENU

Continued from previous page.

6.2 GSM GB2 device information:

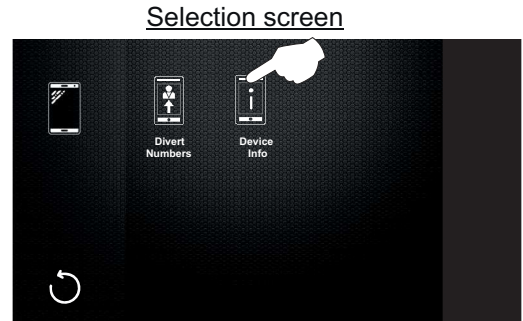
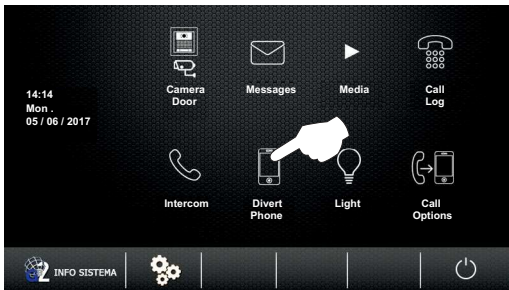
To access the **GSM GB2 device information**, press option 'Divert Phone'. The following selection screen will be displayed; press option 'Divert Device Info'.



The divert device information screen will then be displayed, indicating the status of the GSM GB2 module. Press option  to exit.

Selection screen

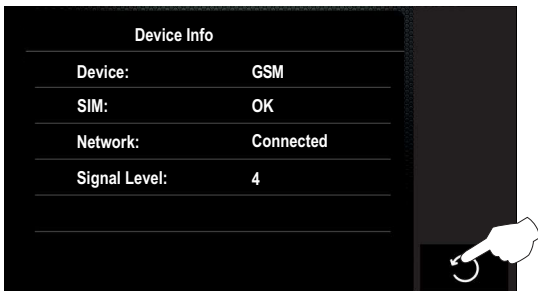

7.1 Activating the external light:

To activate the external light, press option 'Light'. The outdoor light (SAR-GB2 module required) will activate for 1 minute. See the "TSAR-GB2 ML" user manual for how to set other light activation times.

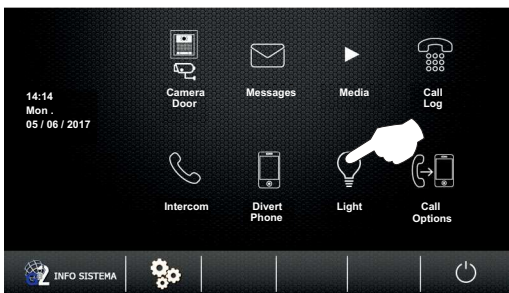

USER MENU

Continued from previous page.

8.1 Do not disturb mode:

To access do not disturb mode, press 'Call Options'. The following selection screen will be displayed.

Selection screen

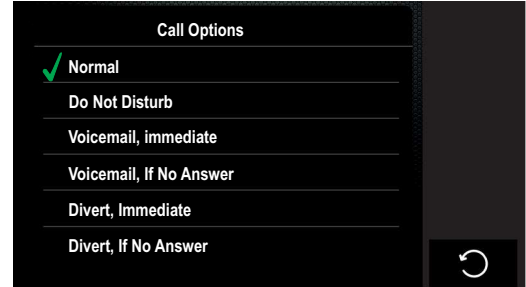
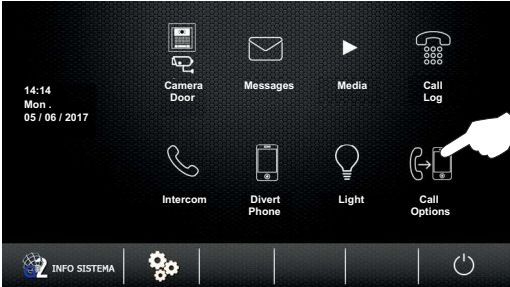

To enable do not disturb mode, press option 'Do Not Disturb' on the master monitor. Icon ✓ will be enabled in the option selected and icon 🔊✗ will be displayed on the main menu screen and the LED on the front of the master and slaves monitors in the apartment, indicating that the function is enabled. The monitors in the apartment will not receive door panel or intercom calls. Press option ↻ to exit and return to the main menu.

Selection screen

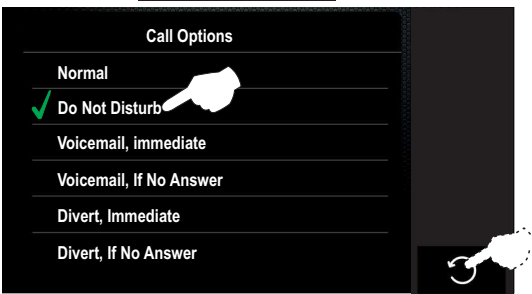

Main menu screen

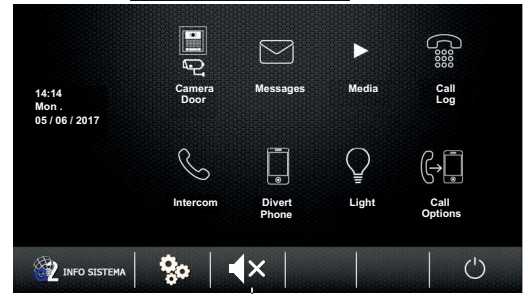

'Do not disturb' mode is enabled. ←

To disable do not disturb mode, press option 'Normal' and icon 🔊✗ will no longer be displayed on the main menu screen or the LED on the front of the main and slave monitors in the apartment. Press option ↻ to exit and return to the main menu.

Selection screen

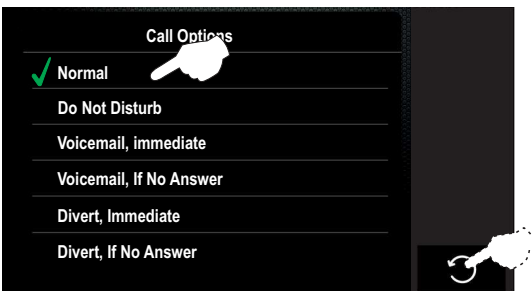

Main menu screen

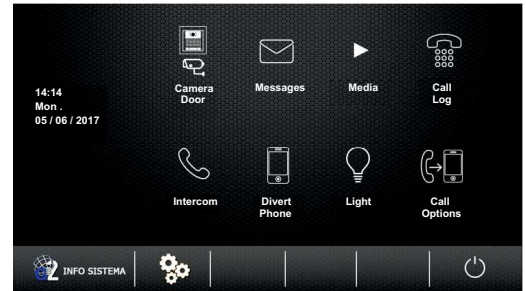

8.2 Leave a message: No function

'Voicemail, Immediate' and 'Voicemail, If No Answer' modes: No function.

Selection screen

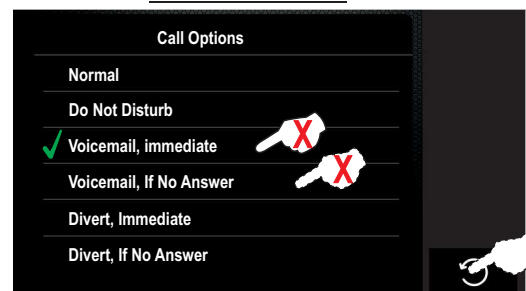
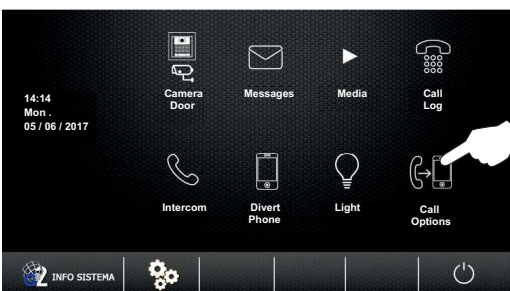

Continued overleaf

USER MENU

Continued from previous page.

8.3 Divert call mode (GSM-GB2 module required):

Important: Before enabling divert call mode, the divert phone numbers need to be configured (see 'Configuring divert call phone numbers' on p. 31).

To access divert call mode, press 'Call Options' on the apartment's master monitor. The following selection screen will be displayed.

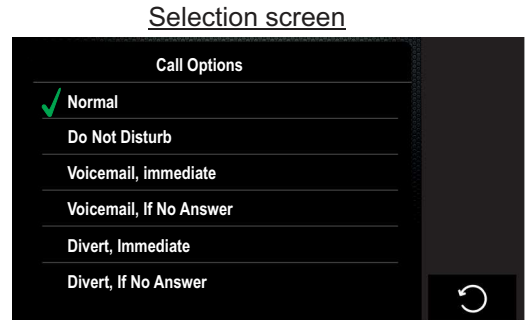
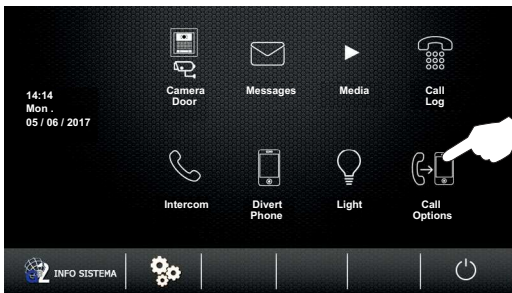

To enable the required divert option, press option 'Divert, Immediate' or 'Divert, If No Answer'. Icon ✓ will be enabled in the option required and icon ⇨ will be displayed on the main menu screen and the LED on the front of the monitor, indicating that the function is enabled. Press option ↻ to exit and return to the main menu.

Selection screen

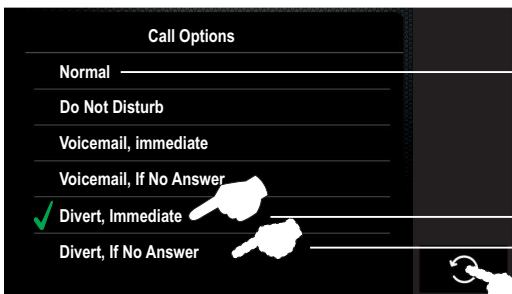

- Monitor 'Normal' mode:
'Do not disturb' mode is not enabled.
'Divert, Immediate' mode is not enabled.
'Divert, If No Answer' mode is not enabled.
- Door panel call mode, immediate divert.
- Door panel call mode, divert if not answered within 35 seconds.
- Return to the main menu screen.

Main menu screen

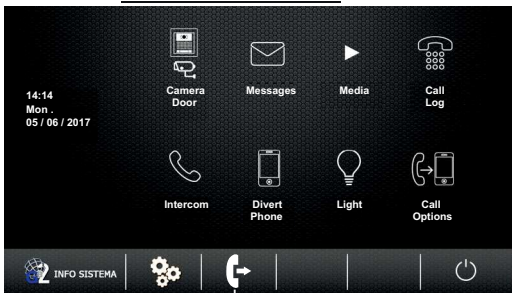

Indicates that divert mode is enabled.

To disable divert call mode, press option 'Normal' and icon ⇨ will no longer be displayed on the main menu screen or the LED on the front of the monitor. Press option ↻ to exit and return to the main menu.

Selection screen

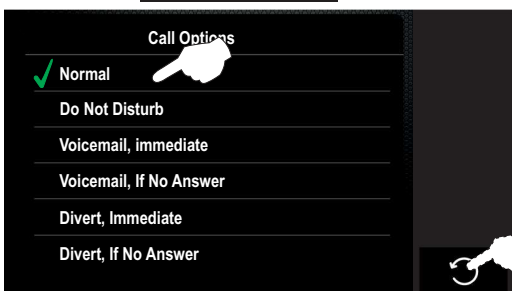

Main menu screen

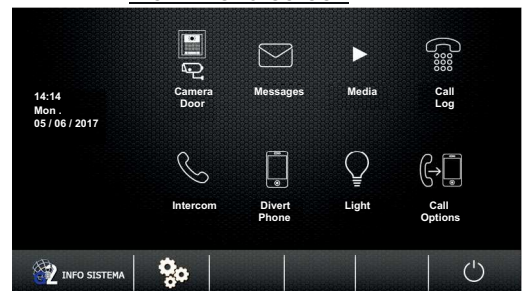

USER MENU

Continued from previous page.

9.1 Settings:

To access the configuration functions, press option . The following settings screen will be displayed.

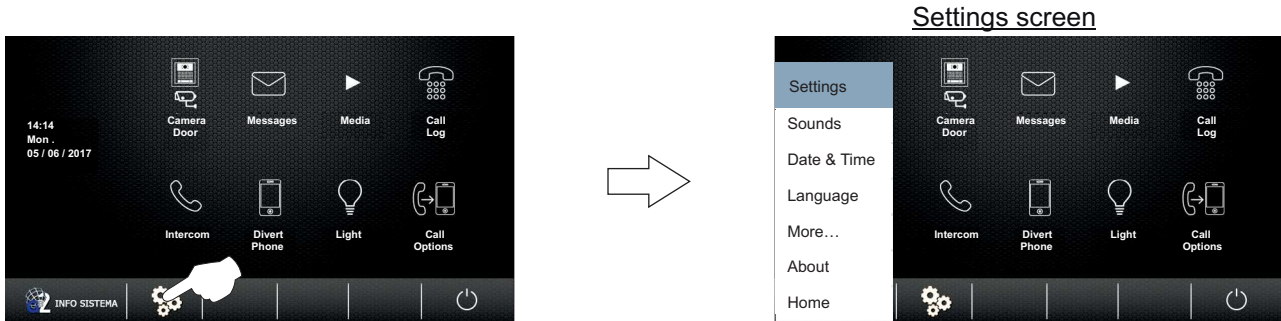

9.1.1 To access the ringtone and volume settings, press option 'Sounds'. The following settings screen will be displayed (default settings: Door tones '19', intercom '01', bell '03' and alert '04'. Day volume '06' and Night volume '03').

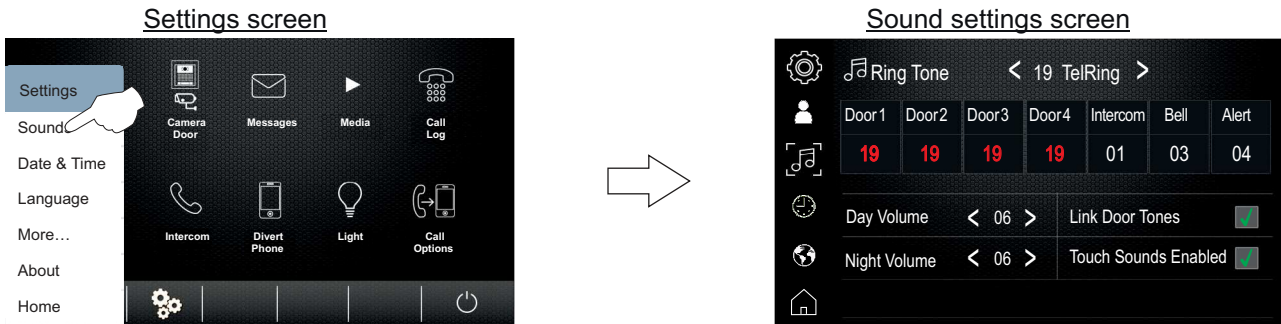

To change the door panel ringtones, press option 'Door 1' and then press < or > to select the melody. Repeat the process to change the ringtones for the other call types. For the door panel ringtones, a different tone for each of the 4 doors or the same tone for all of the 4 doors can be selected, depending on whether option 'Link Door Tones' is selected.

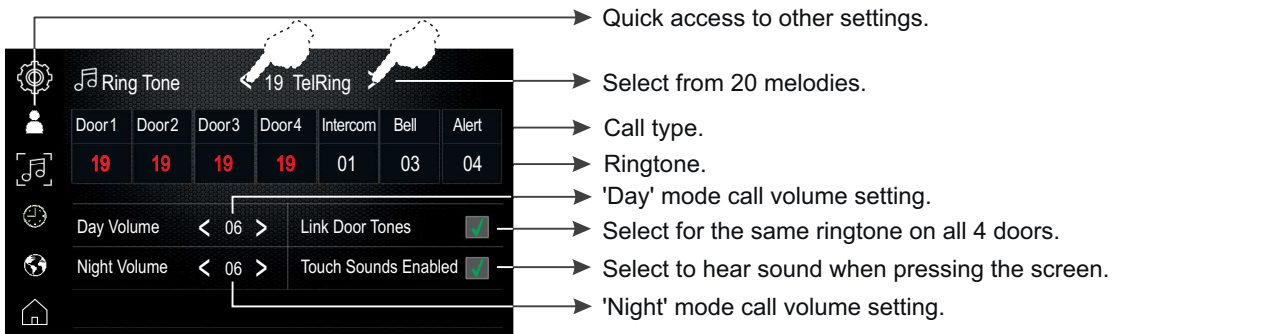

To change the volume level in 'Day' and 'Night' mode for the different types of ringtone, press option < or >. Press option  to return to the main menu page.

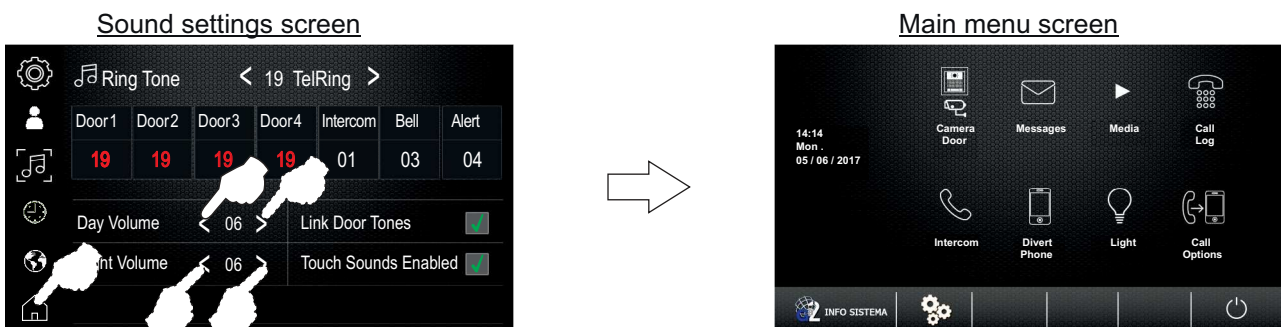

USER MENU

Continued from previous page.

To continue with the configuration functions, press option . The following settings screen will be displayed.

Settings screen

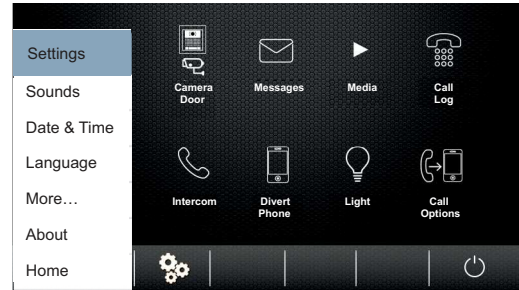
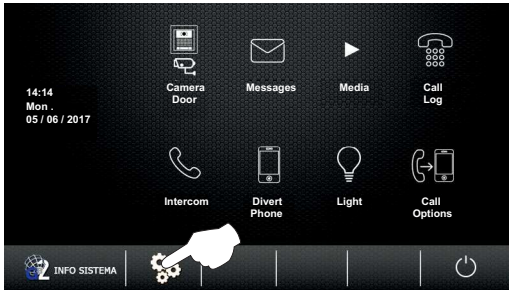

9.1.2 To access the time and date settings, press option 'Date & Time'. The following settings screen will be displayed.

Settings screen

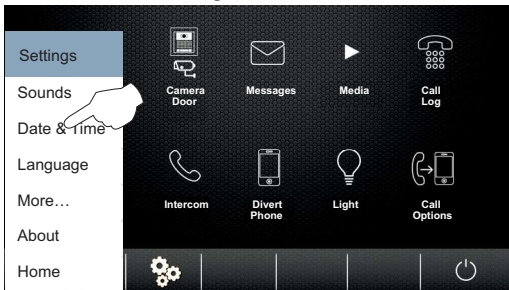

Date and time screen

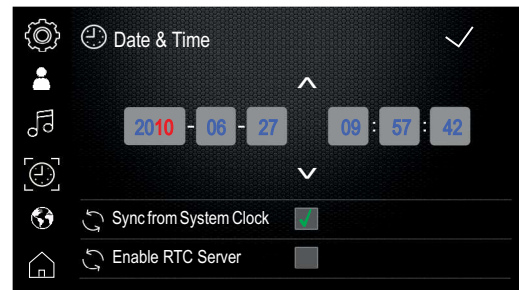

To change the time and date, press selection field '2010' and then press option \wedge or \vee . Repeat the process with the remaining selection fields.

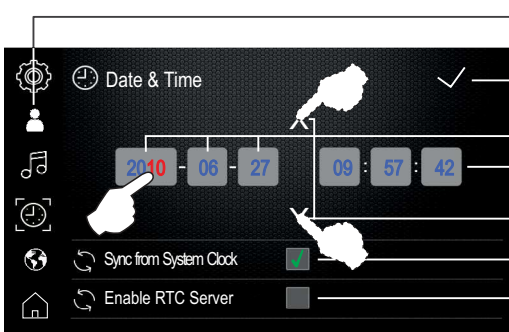

- Quick access to other settings.
- Press to accept and save the new values.
- Selection fields (year - month - day).
- Selection fields (hour: minutes: seconds).
- Change the value selected.
- Leave selected on all monitors.
- Select only on one monitor (with the date and time set); the other monitors will be synchronised with the date and time of the monitor with this box enabled. **To synchronise, disconnect and then reconnect the power supply.**

To accept and save the new values, press option \checkmark and a confirmation tone will be heard on the monitor. Then press option  to return to the main menu page.

Date and time screen

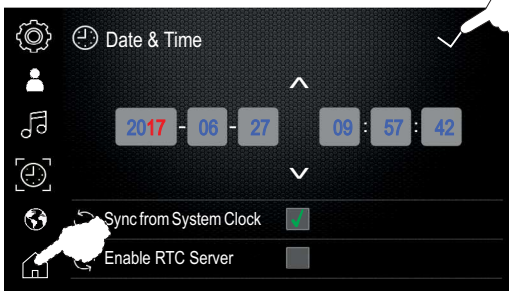

Main menu screen

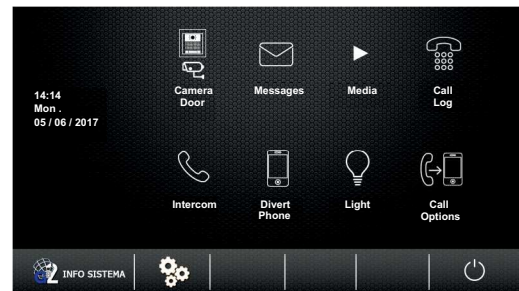

USER MENU

Continued from previous page.

To continue with the configuration functions, press option . The following settings screen will be displayed.

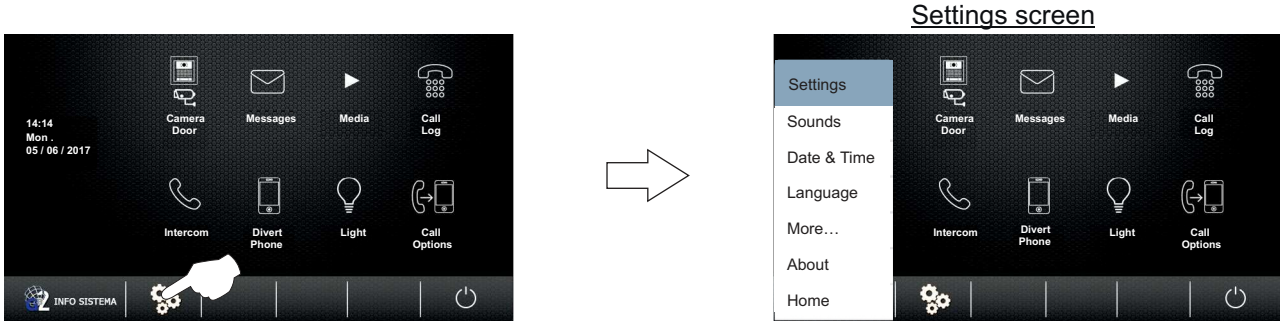

9.1.3 To access the language settings, press option 'Language'. The following settings screen will be displayed.

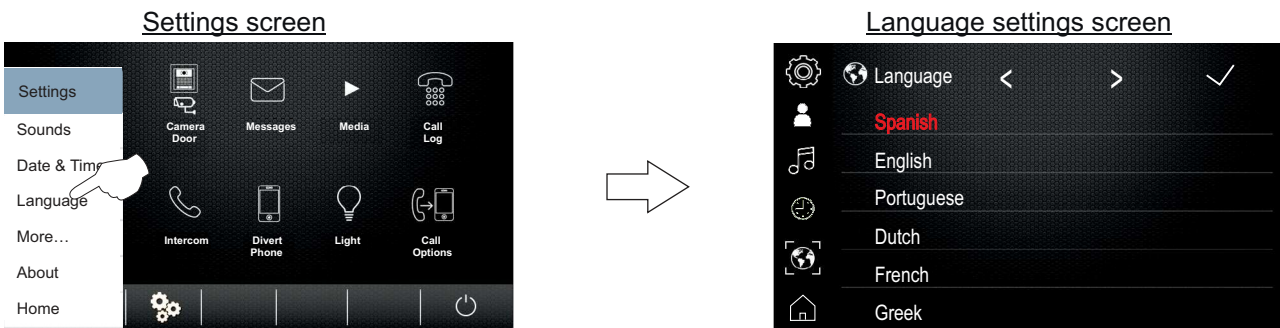

To change the language, press the required language (default setting: Spanish, 'PENTHA GB2/H monitor French').

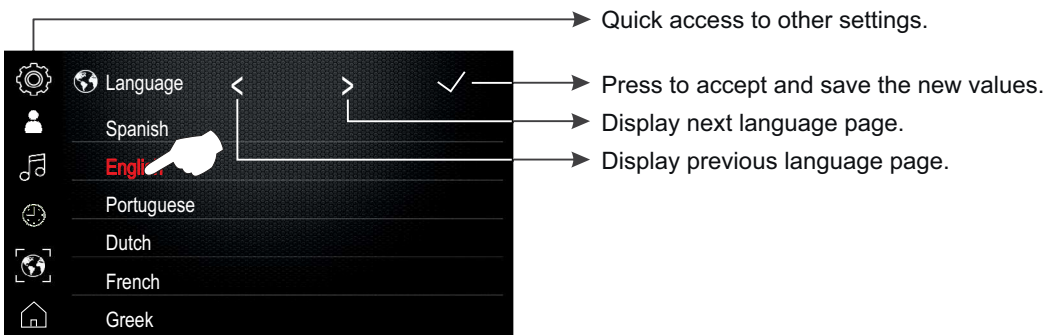

To accept and save the language selected, press option  and a confirmation tone will be heard on the monitor. Then press option  to return to the main menu page.

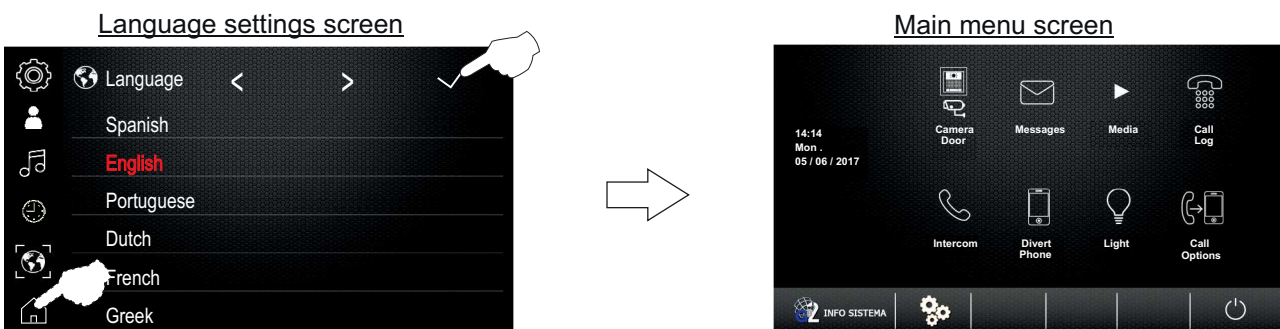

USER MENU

Continued from previous page.

To continue with the configuration functions, press option . The following settings screen will be displayed.

Settings screen

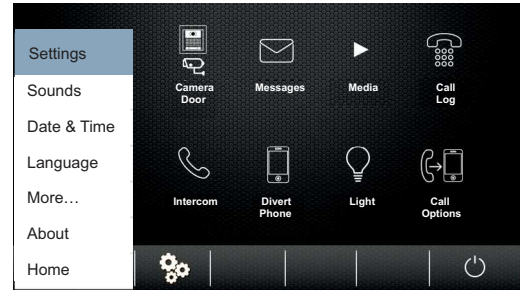
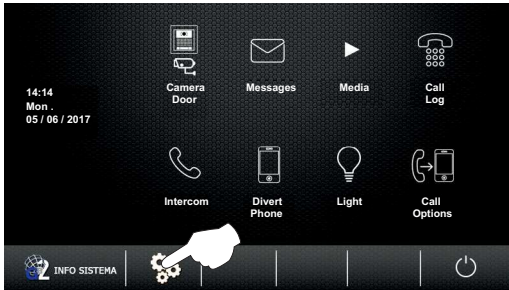

9.1.4 To access the rename door / camera, auto switch-on time and disable intercom settings, press option 'More...'. The following settings screen will be displayed.

Settings screen

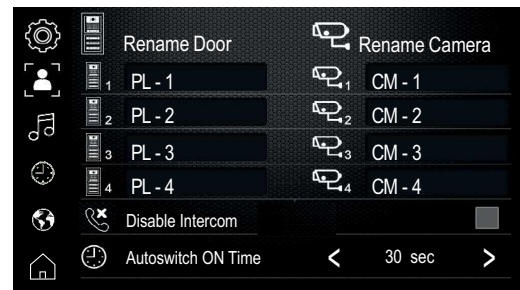
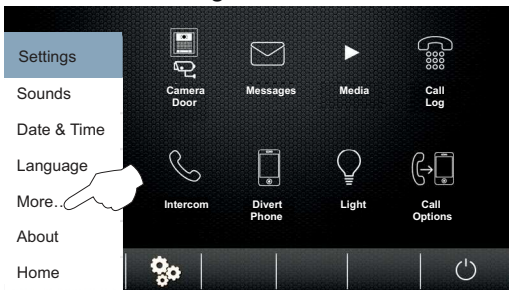

To rename a door / camera, press on the selection field for the required door / camera. The following text editing screen will be displayed. Using the alphanumeric buttons, enter the new text for the door / camera. To save, press 'OK'. To exit without saving, press option . From the selection screen, repeat the steps to rename the doors / cameras in the other selection fields.

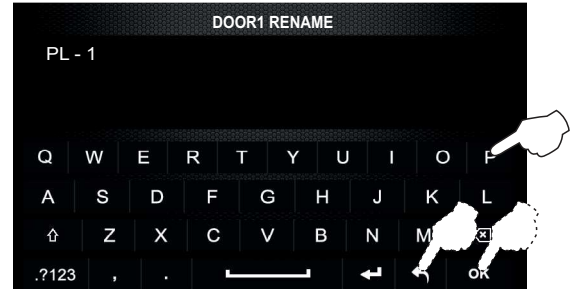
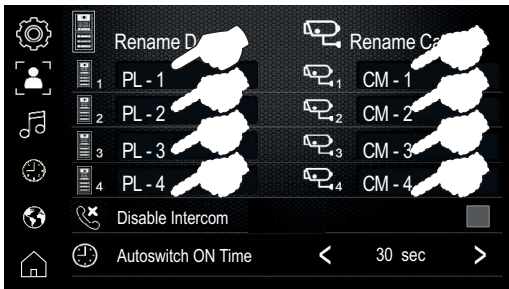

To disable the intercom between apartments function, press option 'Disable Intercom'. (Default setting: Intercom between apartments enabled).

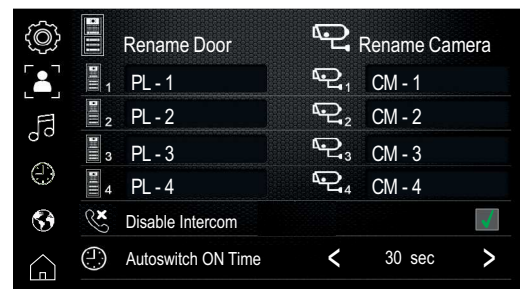
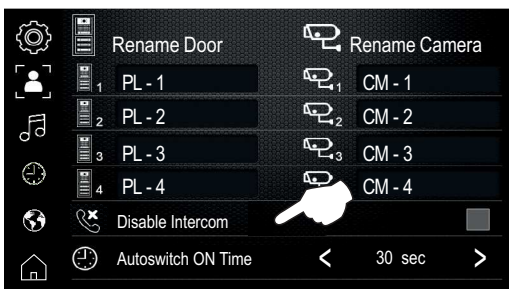

USER MENU

Continued from previous page.

To adjust the auto switch-on time, press option or (default setting: 30 sec.). Then press option to return to the main menu page.

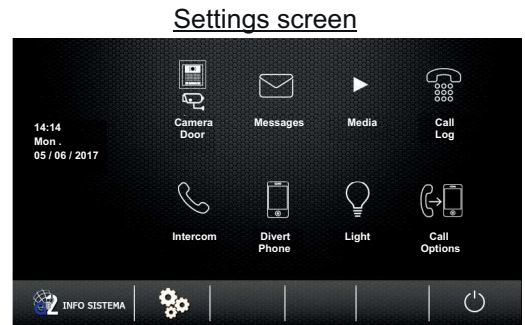
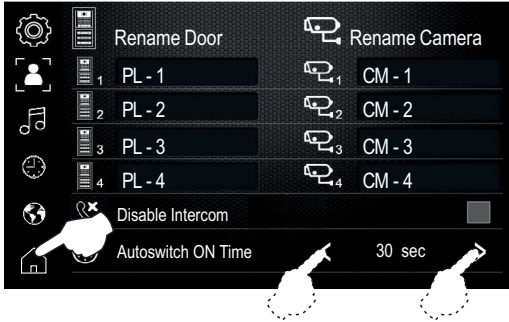

To continue with the configuration functions, press option . The following settings screen will be displayed.

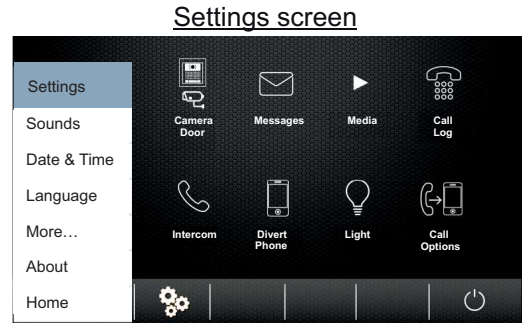
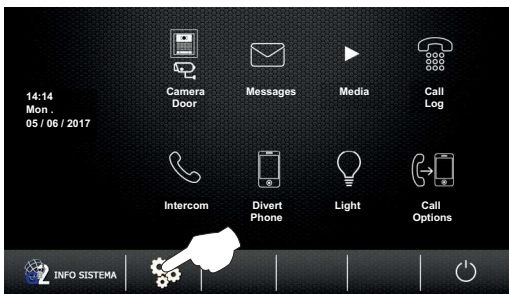

9.1.5 To access the default setup and installer menu settings, press option 'About' or (see p. 40). The following selection and information screen on the monitor will be displayed.

Settings screen

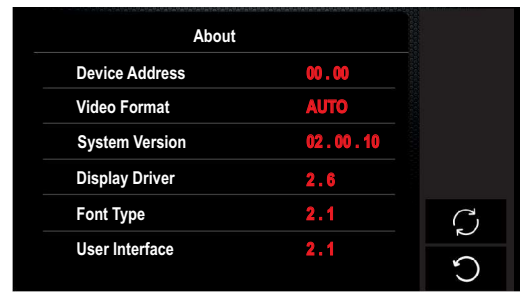
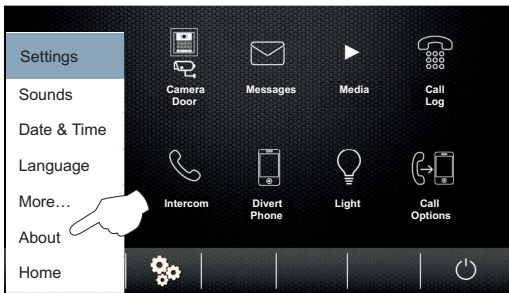

To access the default setup function, press option and the following screen will be displayed. Press option to confirm and leave the default settings in '9.1 Settings' (see pp. 35-39) unchanged or press option to cancel and return to the selection screen.

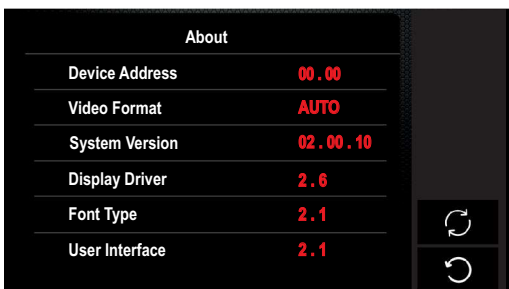

USER MENU

Continued from previous page.

To access the installer menu, press the  logo on the front of the monitor for 3 seconds. The following setup screen will be displayed.

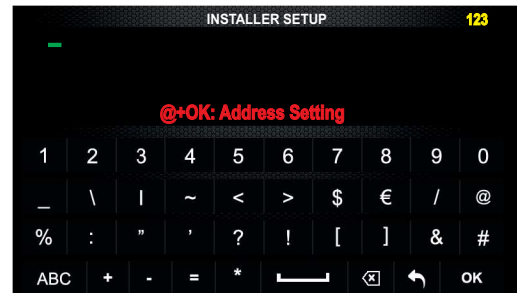
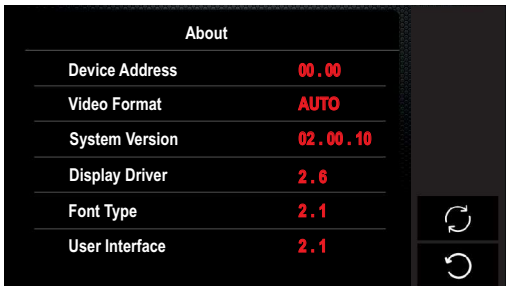

Then enter the function code with the numeric buttons. Confirm the function code entered by pressing 'OK'. Press option  to exit and return to the monitor's selection and information screen.

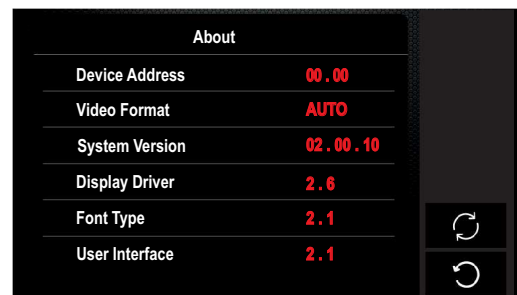

Function codes (installer):

- * [8000]: Master monitor (factory default).
- [8004]: Guard monitor.
- [9015]: Intercom enabled (factory default)
- [2910]: Send the residents list of the configured monitor to all of the building's monitors (installation without RD-GB2A repeater).
- * [8001] to [8003]: Slave monitor 1 to 3.
- [8005]: End guard monitor (factory default).
- [9016]: Intercom disabled.

* Each apartment must have only one master unit; Any other units in the apartment must be configured as slaves.

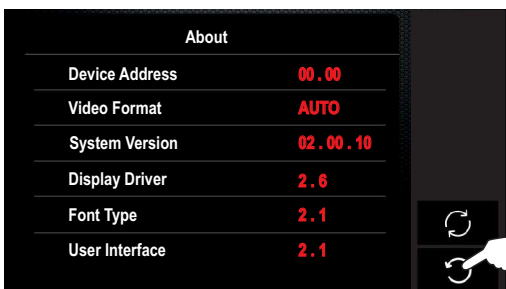

To exit the monitor's selection and information screen, press option . The menu screen will be displayed.

Selection screen

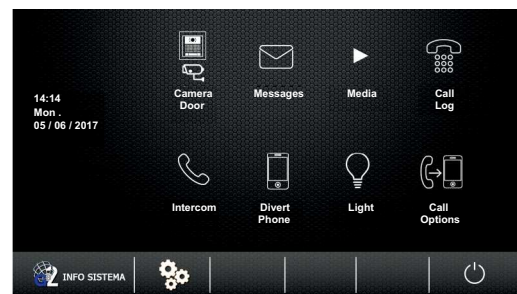

Main menu screen



For a shortcut to accessing the default setup and installer menu settings, press option  and the following selection and information screen on the monitor will be displayed (follow the steps described on pp. 39-40 to adjust the settings). To exit and return to the menu screen, press .

Main menu screen

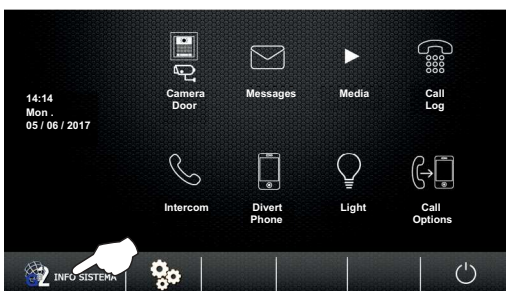

Selection screen

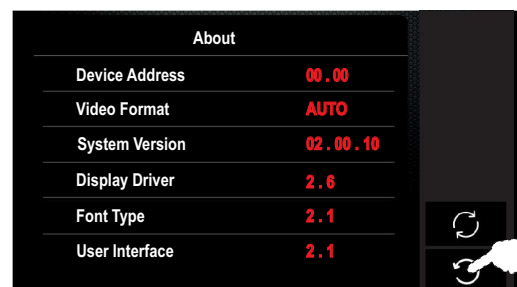

Continued overleaf

USER MENU

Continued from previous page.

To exit the monitor's user menu function, press option (⏻).

Main menu screen

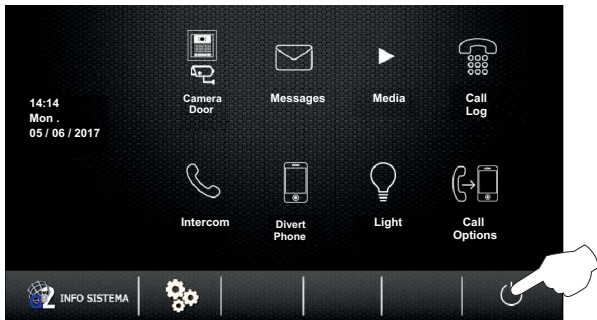

Monitor in standby



Configuring from the menu (monitor address, master/slave and displaying slave monitor image in call):

The Pentha monitor enables you to configure: address and master / slave on the monitor.

Step 1: To access the menu, the monitor must be in standby. Press the screen or on the **Golmar** logo on the front of the monitor. The main menu options screen will then appear. **Note:** For example, move DIP 1 of the configuration DIP switch from ON to OFF (see p. 4) and go directly to the selection screen (see p. 42).

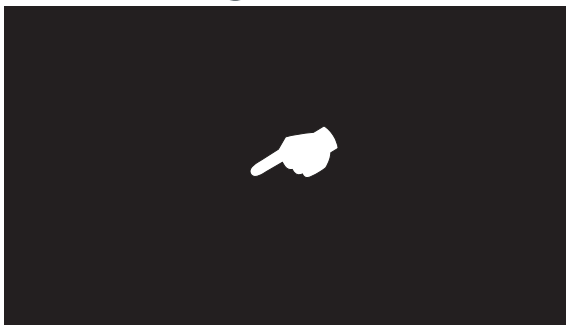

Main menu screen

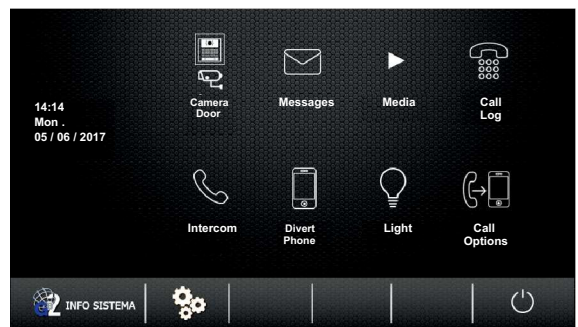

Then press **INFO SISTEMA** and the following selection and information screen will be displayed.

Main menu screen

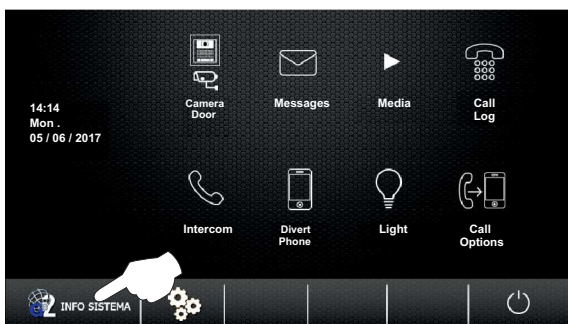

Selection and information screen

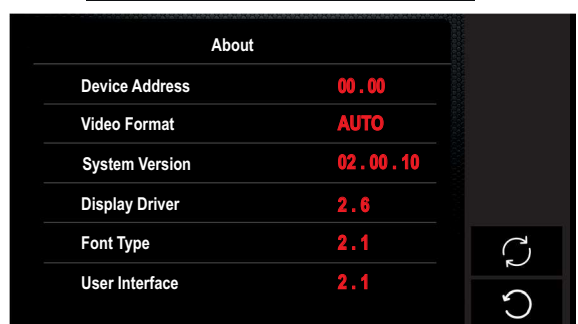

To access the installer menu, press the **Golmar** logo on the front of the monitor for 3 seconds. The following installer screen will be displayed.

Selection and information screen

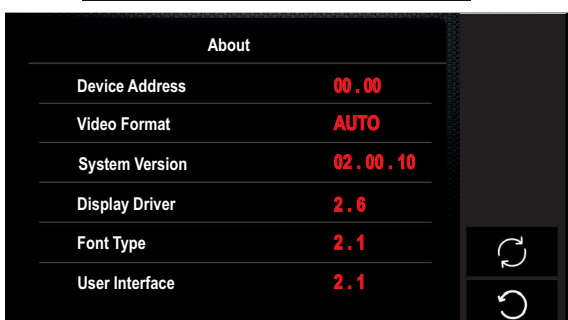

Installer screen

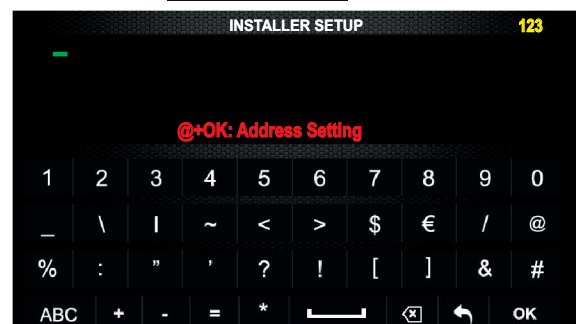

Continued from previous page.

To access the selection screen to configure the address and master / slave of the monitor, enter function code '@' and confirm by pressing 'OK'.

Installer screen

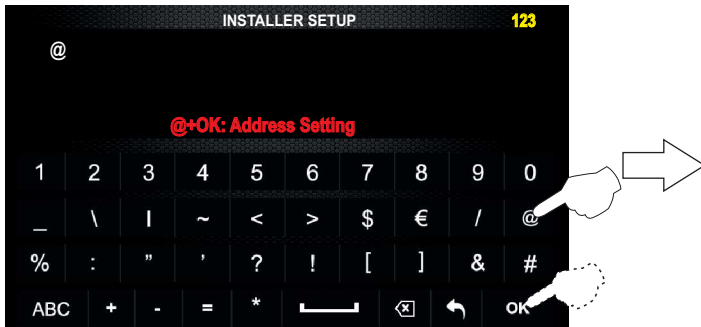

Selection screen

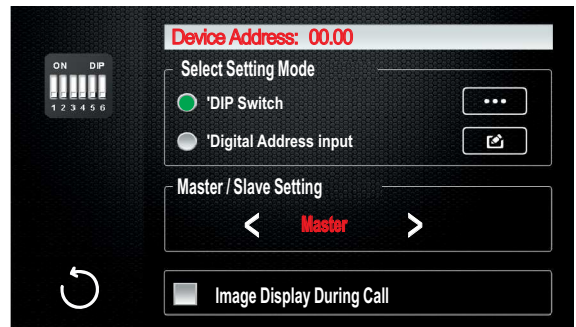

Step 2: The following functions can then be performed on the selection screen:

Selection screen

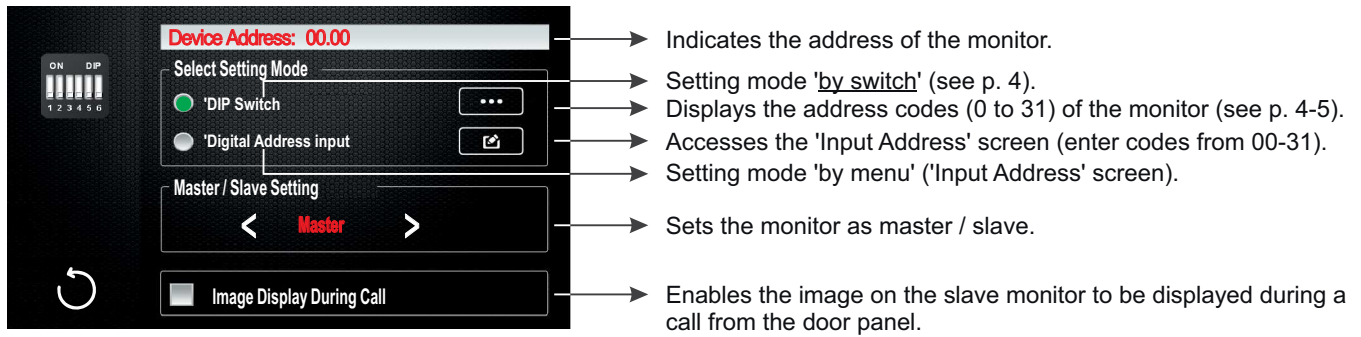

To configure the monitor with manual setting mode 'by menu', press 'Digital Address Input' and then press option to bring up the following settings screen.

Selection screen

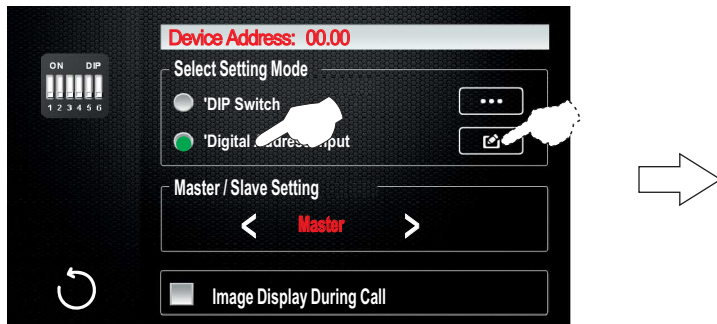

Settings screen

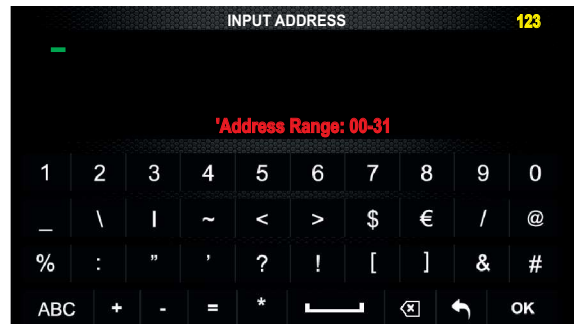

Enter the required monitor address (address from 00 to 31). Confirm the address entered by pressing 'OK', then press to exit and return to the selection screen.

Settings screen



Selection screen

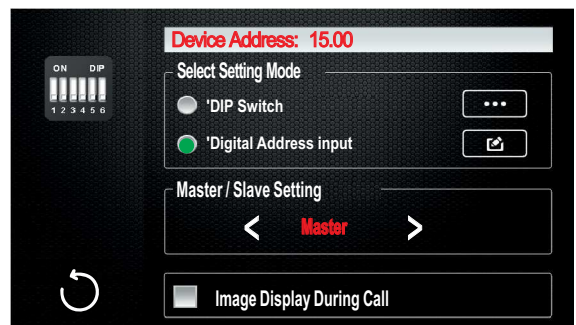

Continued from previous page.

Then press < or > to change the 'Master / Slave Setting', showing in 'Device Address' the address and master or slave configured on the monitor.

Selection screen

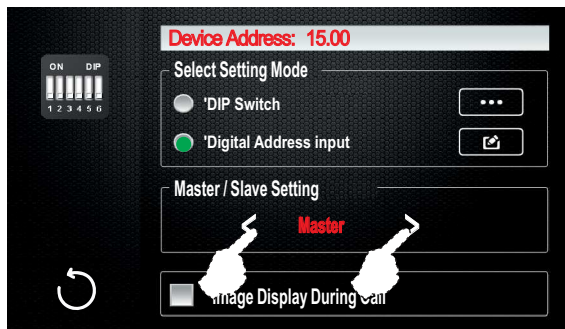

Selection screen

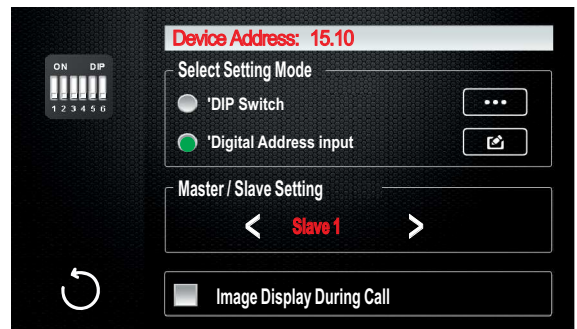

* **Important:** Each apartment must only have one master unit; if there are other units, they must be configured as slaves.

Step 3: To exit the selection screen, press option . The main menu screen will be displayed.

Selection screen

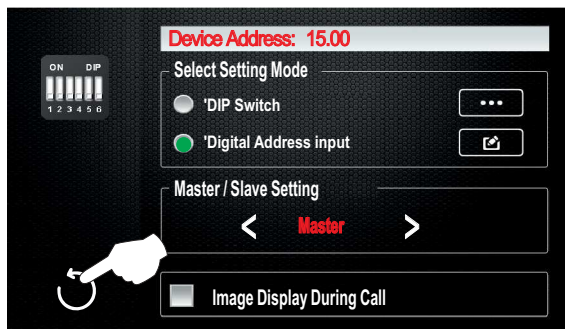

Main menu screen

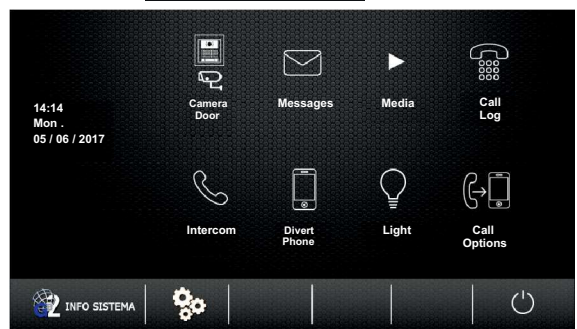

To exit the monitor's user menu function, press .

Main menu screen

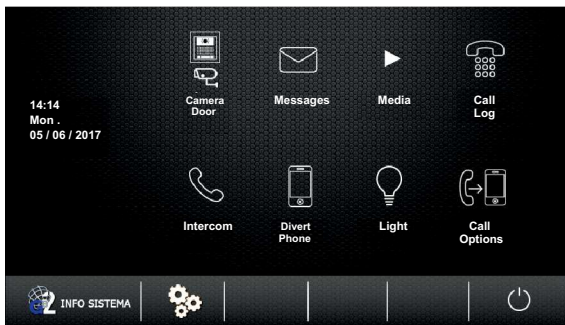

Monitor in standby



CLEANING THE MONITOR

- Do not use solvents, detergents or cleaning products that contain acids, vinegar or abrasive components.
- Use a soft damp cloth (not wet) that sheds no fibres.
- Always wipe the monitor in the same direction, from top to bottom.
- After cleaning the monitor, remove any moisture with a soft dry cloth that sheds no fibres.

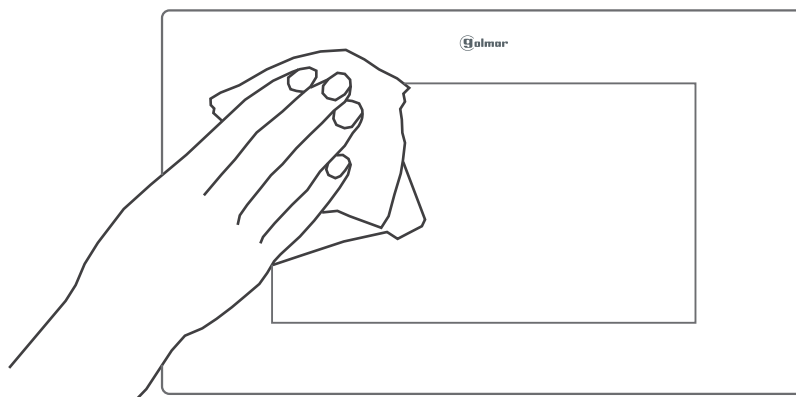



golmar@golmar.es
www.golmar.es

GOLMAR S.A.
C/ Silici, 13
08940- Cornellá de Llobregat
SPAIN



Golmar se reserva el derecho a cualquier modificación sin previo aviso.
Golmar se réserve le droit de toute modification sans préavis.
Golmar reserves the right to make any modifications without prior notice.

USER MENU (ANNEX)

To change the 'Day' mode start and finish time:

The monitor's ringtone is louder during the time set as day mode (default setting of 06:00 to 18:00).

Step 1: To access the menu, the monitor must be in standby. Press the screen or on the **Golmar** logo on the front of the monitor. The main menu options screen will then appear.

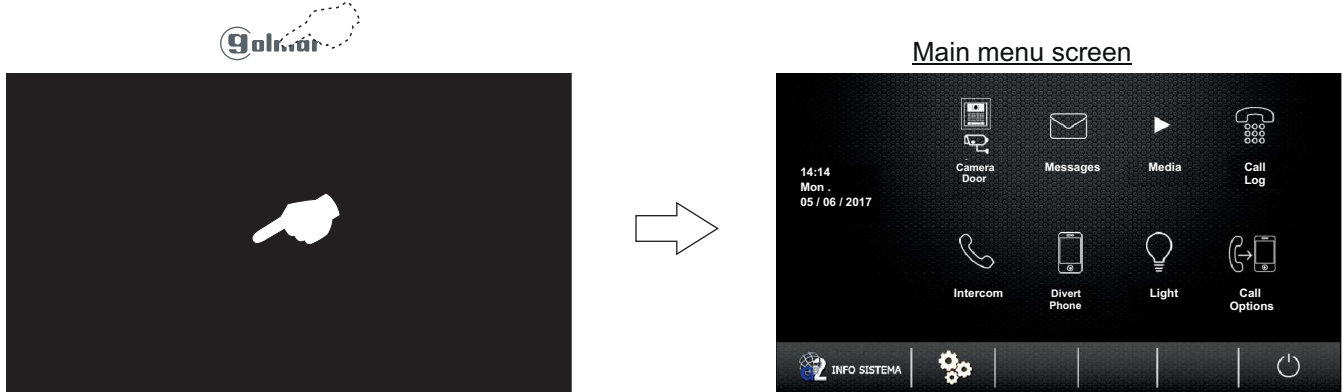

Then press **INFO SISTEMA** and the following selection and information screen will be displayed.

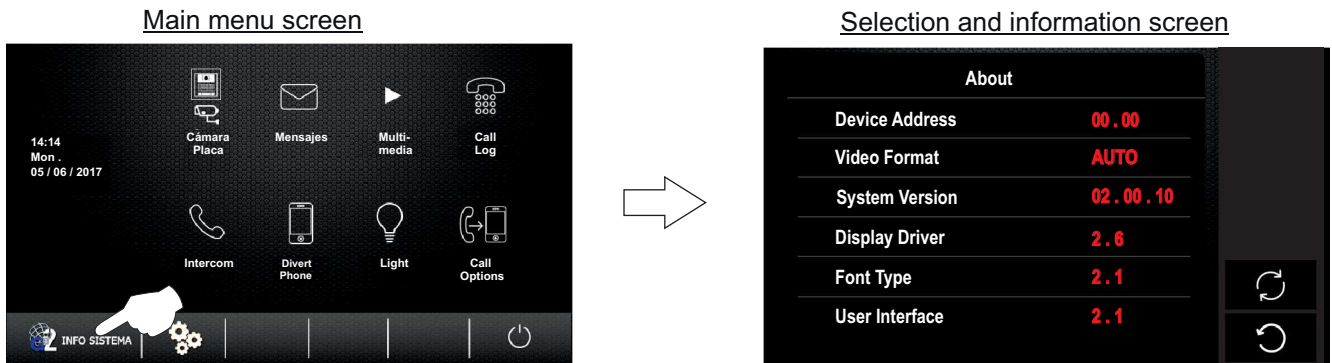

To access the installer menu, press the **Golmar** logo on the front of the monitor for 3 seconds. The following installer screen will be displayed.

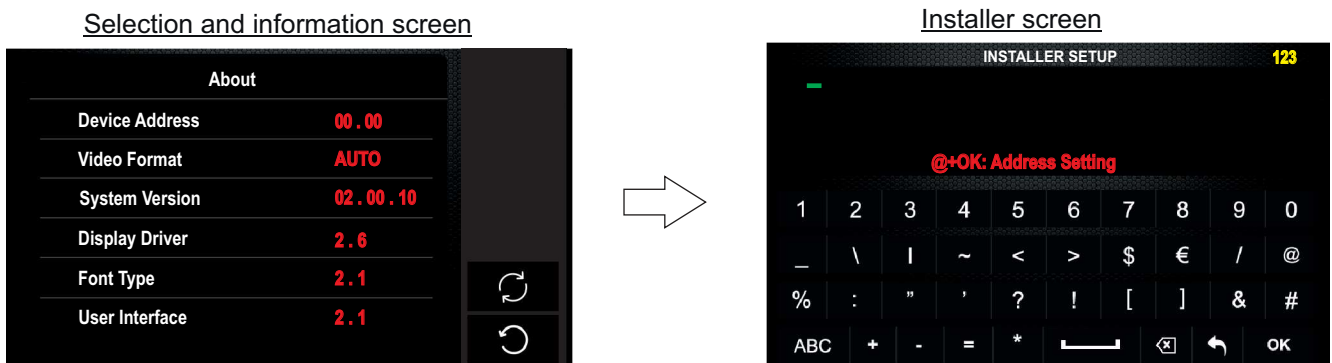

To access the 2nd installer screen, press the **Golmar** logo on the front of the monitor again for 3 seconds.

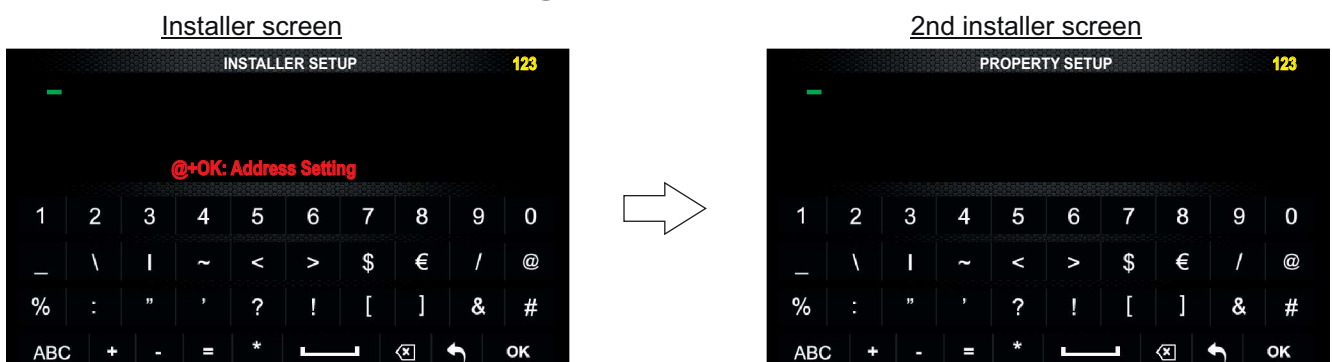

Continued from previous page.

Step 2: Then enter the function code with the alphanumeric buttons. Confirm the function code entered by pressing 'OK'. Press option  to exit and return to the monitor's selection and information screen.

2nd installer screen



Selection and information screen

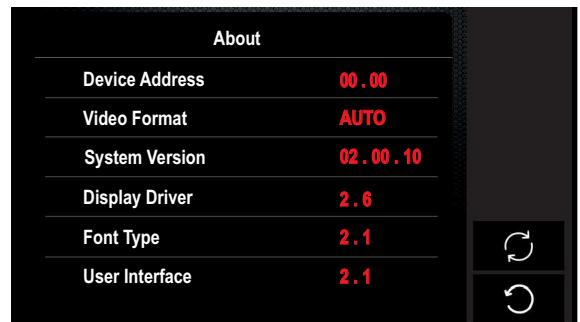

Function code:

To set day mode to start at 07:00 in the morning and finish at 21:00 at night, enter the following code (with the hours in hexadecimal):

1#0#62#2#0#07,15#

- Day mode finish time (in hexadecimal).
- Day mode start time (in hexadecimal).

Decimal time to hexadecimal time conversion table:

Decimal	Hexadecimal	Decimal	Hexadecimal	Decimal	Hexadecimal	Decimal	Hexadecimal
01	01	07	07	13	0d	19	13
02	02	08	08	14	0e	20	14
03	03	09	09	15	0f	21	15
04	04	10	0a	16	10	22	16
05	05	11	0b	17	11	23	17
06	06	12	0c	18	12	24	18

Important: If the function code contains letters, enter them in lower case.

Step 3: To exit the monitor's selection and information screen, press option . The menu screen will be displayed.

Selection and information screen

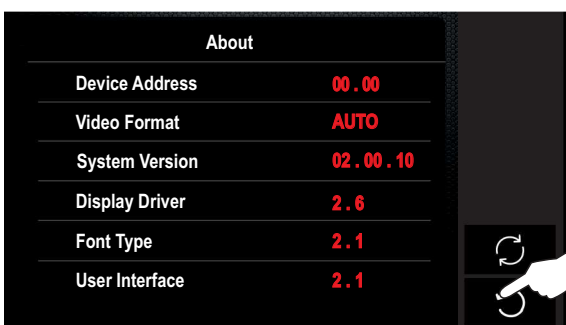

Main menu screen

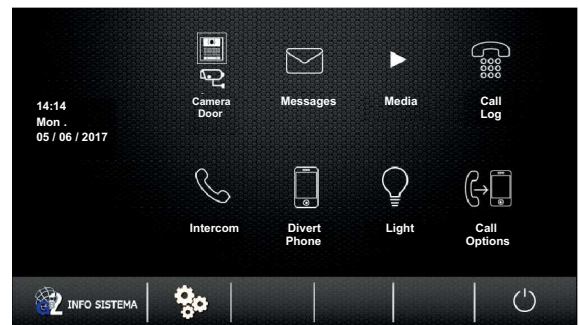

Then press option  to exit the monitor's user menu function.

Main menu screen

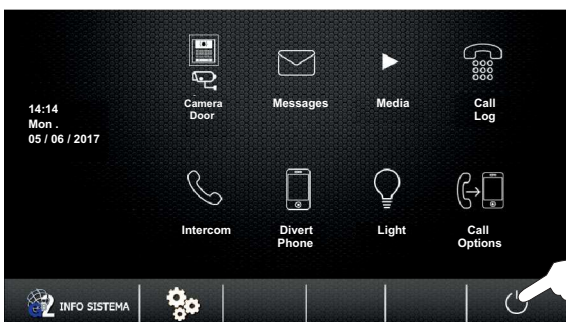

Monitor in standby

